



Frequency inverters M-Max™, H-Max™

Frequency inverters permit the continuously variable speed control of three-phase asynchronous motors, by converting a one- or three-phase alternating current of specific frequency and voltage amplitudes into a three-phase alternating current with variable voltage amplitude.

The M-Max™ and H-Max™ device series find universal application:

Device series M-Max™ is preferred in machinery construction; device series H-Max™ is primarily used in heating, ventilation and air conditioning (HVAC).



Frequency inverters M-Max™

Output voltage with sinusoidal evaluated Pulse-Width Modulation (PWM) for voltage/frequency control (U/f control) and voltage-steered vector control

MMX...-N...: Compact construction type in three sizes, protection type IP20

MMX...-F...: Compact construction type in three sizes, protection type IP20, with internal radio interference suppression filter (EMC)

MMX12..., MMX32...: Nominal current 1.7 – 9.6 A with 230 V single phase mains connection, assigned motor power 0.25 – 2.2 kW (230 V) → Page 10/5

MMX34...: Nominal current 1.3 – 14 A with 400 V three-phase mains connection, assigned motor power 0.37 – 7.5 kW (400 V) → Page 10/7

Frequency inverters H-Max™

Output voltage with sinusoidal evaluated Pulse-Width Modulation (PWM) for voltage / frequency control (U/f control) and sensorless flow vector control

HMX...-1-B: Compact construction type in five sizes, protection type IP21, with internal radio interference suppression filter (EMC) and intermediate circuit choke

HMX...-2-B: Compact construction type in six sizes, protection type IP54, with internal radio interference suppression filter (EMC) and intermediate circuit choke

HMX32...: Nominal current 3.7 – 310 A with 230 V three-phase mains connection, assigned motor power 0.75 – 90 kW (230 V) → Page 10/10

HMX34...: Nominal current 3.4 – 310 A with 400 V three-phase mains connection, assigned motor power 1.1 – 60 kW (400 V) → Page 10/12



Eaton After Sales Service

Extended warranty for authorized commissioning
→ Chapter 22

Frequency inverters

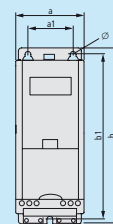
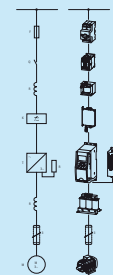

System overview	
Frequency inverter M-Max™	10/2

Description	
Frequency inverter M-Max™	10/3
Frequency inverters M-Max™ in overview	10/4

Ordering	
Frequency inverter M-Max™	10/5

System overview	
Frequency inverter H-Max™	10/8

Description	
Frequency inverter H-Max™	10/9

Ordering	
Frequency inverter H-Max™	10/10

Description	
Braking resistances	10/13
Interface cards	10/14
Mains chokes, motor chokes	10/16

Ordering	
Accessories for M-Max™, H-Max™	
Braking resistances	10/17
Interface cards	10/18
Radio interference suppression filters	10/19
Enclosure accessories	10/19
Mains chokes	10/20
Motor chokes	10/21

Engineering	
M-Max™, H-Max™ key to part numbers	10/22
Components of the Power Drives System (PDS)	10/23
Connecting example for M-Max™	10/26
Assigned switching and protective elements for M-Max™	10/28
Assigned switching and protective elements for H-Max™	10/30

Technical data	
Frequency inverter M-Max™	10/32
Mains chokes, motor chokes	10/36

Dimensions	
Frequency inverter M-Max™	10/38
Frequency inverter H-Max™	10/39
Braking resistances	10/41
Radio interference suppression filters	10/42
Mains chokes, motor chokes	10/43



System overview

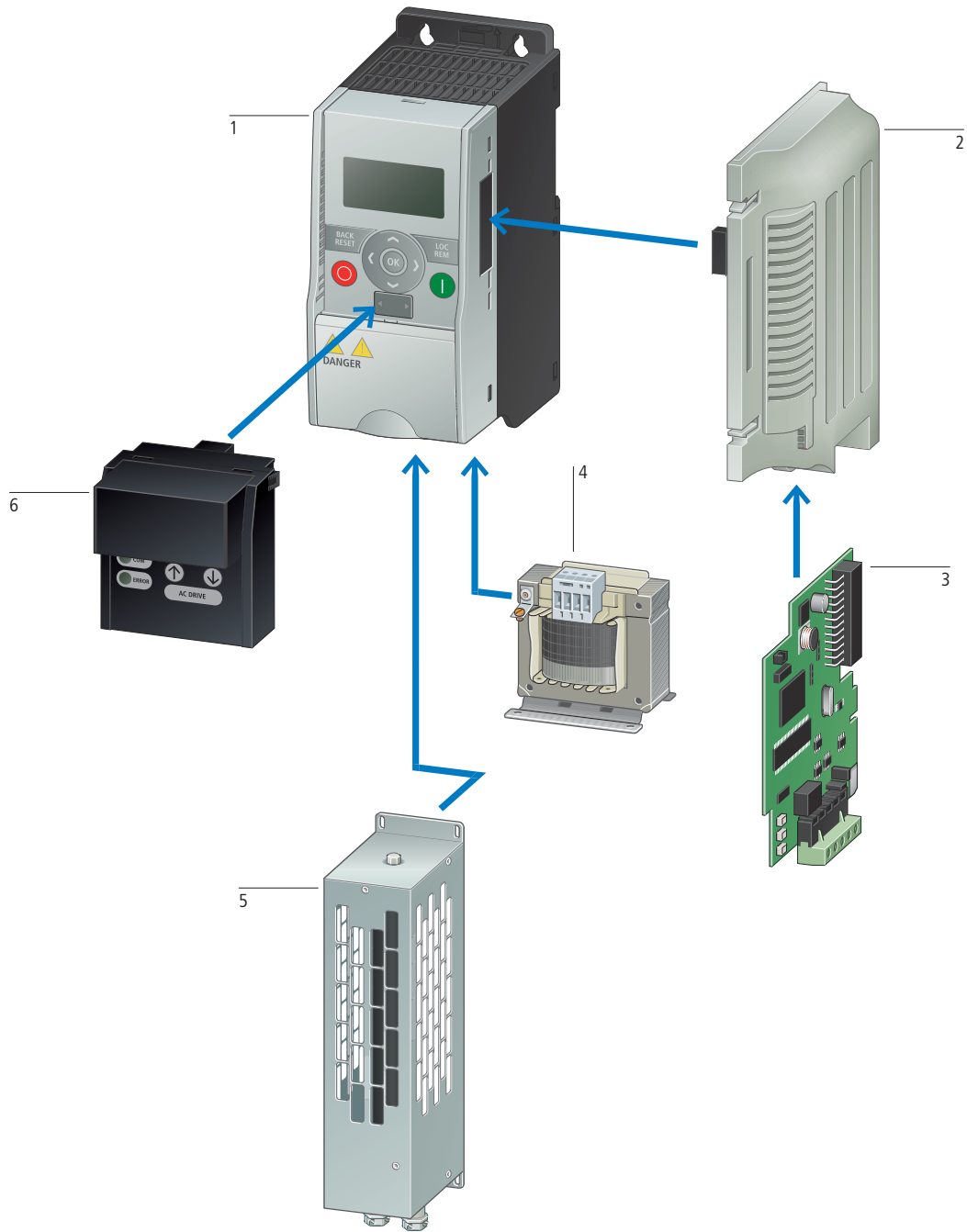

Basic device

Frequency inverters	1
MMX12...	
Mains: single-phase, 230/240 V	
Assigned motor rating from 0.25 up to 2.2 kW (230 V)	
→ Page 10/5	
MMX32...	
Mains: 3-phase, 230/240 V	
Assigned motor rating from 0.25 up to 2.2 kW (230 V)	
→ Page 10/6	
MMX34...	
Mains: 3-phase, 400/480 V	
Assigned motor rating from 0.37 up to 7.5 kW (400 V)	
→ Page 10/7	

System accessories

Communication module	3
Versions	
• CANopen fieldbus connection	
• PROFIBUS DP fieldbus connection	
• DeviceNet fieldbus connection	
→ Page 10/18	
PC interface card	6
MMX-COM-PC communication module	
→ Page 10/18	
Mounting frame	2
For fieldbus connection	
→ Page 10/18	

Accessories

Mains chokes	4
→ Page 10/20	
Motor chokes	4
→ Page 10/21	
Braking resistor	5
→ Page 10/17	

Description



Application

The frequency inverters of the M-Max™ series allow a continuously variable speed control of three-phase asynchronous motors. They are specially suited for applications in which ease of handling and cost-effectiveness have a high priority. The characteristics-controlled voltage/frequency (U/f) control already allows a wide range of applications even with the default settings: from simple pump and fan drives, standard packaging applications to the operation of multiple motors in horizontal transportation and conveying.

With sensorless vector control, an individual drive can also be used in demanding applications, in which a high torque and concentricity in the lower speed range are vital, such as in the plastics and metal industries, the textile, paper and printing industries or in crane and elevator systems.

Rated operational currents from 1.4 to 21 A allow the operation of standard four-pole asynchronous motors in an assigned rating range of:

- 0.25 to 2.2 kW at 230 V (single-phase mains connection),
- 0.25 to 2.2 kW at 230 V (three-phase mains connection),
- 0.37 to 7.5 kW at 400 V (three-phase mains connection).

Features

- Compact design through state-of-the-art IGBT modules
- Integrated radio interference suppression filter (EMC)
- Keypad with backlit LCD display
- 6 digital inputs (24 V DC) for sink- and source-type control
- 2 relays (1 changeover contact, 1 normally open contact, 230 V)
- 1 transistor output (N/O or N/C, 48 V DC)
- 2 analog inputs (0 to +10 V, 4 to 20 mA), selectable and scaleable
- 1 analog output (0 to +10 V), scaleable
- 1 serial interface (RS485, Modbus RTU)
- Built-in braking transistor with size MMX34...
- Optional fieldbus connection (CANopen, PROFIBUS-DP, DeviceNet)
- User-friendly commissioning through fast configuration and application menu
- Compliance with global standards to CE, UL, c-UL and c-Tick

Functions

A comprehensive range of protection functions allow safe operation and the protection of frequency inverter, motor and application. They offer protection against:

- Overcurrent, ground fault
- Overload (electronic motor protection)
- Overtemperature
- Overvoltage, undervoltage

Further functions are:

- Restart inhibit
- U/f control or sensorless vector control
- Double starting current and 1.5 times overcurrent
- PID controller
- Sequence control
- Braking control (DC braking)
- 8 fixed frequencies
- Electronic motor potentiometer
- Logic function (AND, OR, XOR)
- Upper and lower frequency and current limits
- Frequency hopping (frequency masking)
- DC braking before start and up to motor standstill
- 2 parameter sets

Documentation

An instructional leaflet and a CD are included with each frequency inverter of the M-Max™ series.

The instructional leaflet is a quick guide with illustrations and notes in 23 languages about the correct handling, mounting and electrical connection of the device. The CD contains the instructional leaflet as well as the Hardware and Engineering manual in several languages.

The current documentation is also available for download from www.moeller.net/support







	MMX12...	MMX32...	MMX34...
Rated operational voltage U_e	230 V	230 V	400 V
System configuration			
1 AC 208 V - 15 % ... 240 V + 10 %	●	-	-
3 AC 208 V - 15 % ... 240 V + 10 %	-	●	-
3 AC 380 V - 15 % ... 480 V + 10 %	-	-	●
Mains frequency	50/60 Hz ± 10 %	50/60 Hz ± 10 %	50/60 Hz ± 10 %
Rated operational current I_e	1.7 - 9.6 A ¹⁾	1.7 - 11 A ¹⁾	1.3 - 14 A ¹⁾
Rated operational current	100 % I_e , continuous current at max. +50 °C	100 % I_e , continuous current at max. +50 °C	100 % I_e , continuous current at max. +50 °C
Starting current	200 % I_e for 2 s every 20 s	200 % I_e for 2 s every 20 s	200 % I_e for 2 s every 20 s
Overload current	150 % I_e for 60 s every 600 s	150 % I_e for 60 s every 600 s	150 % I_e for 60 s every 600 s
Assigned motor rating at rated operational voltage U_{LN}	0.25 - 2.2 kW ¹⁾	0.25 - 2.2 kW ¹⁾	0.37 - 7.5 kW ¹⁾
Operating temperature	-10 - +50 °C	-10 - +50 °C	-10 - +50 °C
Operating mode	U/f control, sensorless vector control	U/f control, sensorless vector control	U/f control, sensorless vector control
Pulse frequency (sinusoidal PWM)	1 - 16 kHz (default settings: 6 kHz)	1 - 16 kHz (default settings: 6 kHz)	1 - 16 kHz (default settings: 6 kHz)
Output voltage	0 - U_{LN} V	0 - U_{LN} V	0 - U_{LN} V
Output frequency	0 - 50 Hz (default settings: 50 Hz)	0 - 50 Hz (default settings: 50 Hz)	0 - 50 Hz (default settings: 50 Hz)
Radio interference suppression filter (EMC)			
Internal	● (for MMX...F...)	● (for MMX...F...)	● (for MMX...F...)
Optional	● (for MMX...N...)	● (for MMX...N...)	● (for MMX...N...)
DC link choke	-	-	-
Protection type			
IP20	●	●	●
IP21/NEMA1	● (optional)	● (optional)	● (optional)
IP54	-	-	-
Keypad	●	●	●
Display	LCD, 7 segment	LCD, 7 segment	LCD, 7 segment
Communication interface			
Internal	RS485, Modbus RTU, system interface	RS485, Modbus RTU, system interface	RS485, Modbus RTU, system interface
Optional	CANopen or PROFIBUS-DP	CANopen or PROFIBUS-DP	CANopen or PROFIBUS-DP
Control signal terminals			
Digital input	6 (max. +30 V DC, $R_i > 12$ k Ω)	6 (max. +30 V DC, $R_i > 12$ k Ω)	6 (max. +30 V DC, $R_i > 12$ k Ω)
Digital output	1 (max. 48 V DC, max. 50 mA)	1 (max. 48 V DC, max. 50 mA)	1 (max. 48 V DC, max. 50 mA)
Analog input	2 (0 - +10 V, 4 - 20 mA)	2 (0 - +10 V, 4 - 20 mA)	2 (0 - +10 V, 4 - 20 mA)
Analog output	1 (0 - +10 V, max. 10 mA)	1 (0 - +10 V, max. 10 mA)	1 (0 - +10 V, max. 10 mA)
Relays	2 (1 normally open contact, 1 change-over contact, 250 V, max. 2 A)	2 (1 normally open contact, 1 change-over contact, 250 V, max. 2 A)	2 (1 normally open contact, 1 change-over contact, 250 V, max. 2 A)
PID controller	●	●	●
Internal brake chopper	-	-	● (from 3.3 A rated operational current I_e)
Production quality	RoHS, ISO 9001	RoHS, ISO 9001	RoHS, ISO 9001
Product standard, regulation	IEC61800-3, UL508C	IEC61800-3, UL508C	IEC61800-3, UL508C
Approval, Certification	CE, UL, cUL, c-Tick	CE, UL, cUL, c-Tick	CE, UL, cUL, c-Tick

Notes

¹⁾ The principle here is that the range is not covered by a single device but by the entire device group.

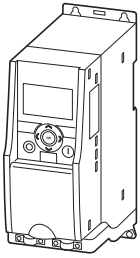
For specific data of the individual performance values → Ordering

Ordering

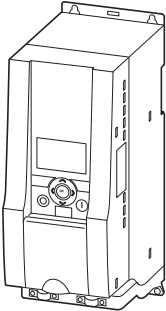
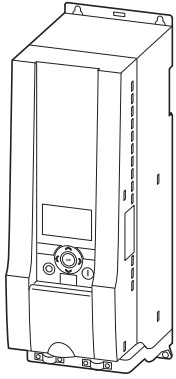
	Rated operational current frequency inverter ¹⁾	Assigned motor rating (50/60 Hz) ²⁾	Rated operational current motor	With internal radio interference suppression filter		Without internal radio interference suppression filter	
				Part no. Article no.	Price See price list	Part no. Article no.	Price See price list
	I _e A	P kW	I _e A				
Rated operational voltage 1 AC 230 V							
	1.7	0.25	1.4	MMX12AA1D7F0-0 121363	1 off  	MMX12AA1D7N0-0 122660	1 off  
	2.4	0.37	2	MMX12AA2D4F0-0 121364		MMX12AA2D4N0-0 122661	
	2.8	0.55	2.7	MMX12AA2D8F0-0 121365		MMX12AA2D8N0-0 122662	
	3.7	0.75	3.2	MMX12AA3D7F0-0 121366		MMX12AA3D7N0-0 122663	
	4.8	1.1	4.6	MMX12AA4D8F0-0 121367		MMX12AA4D8N0-0 122664	
	7	1.5	6.3	MMX12AA7D0F0-0 121368		MMX12AA7D0N0-0 122665	
	9.6	2.2	8.7	MMX12AA9D6F0-0 121369		MMX12AA9D6N0-0 122666	

Notes





¹⁾ Rated operational current at an operating frequency of 6 kHz and an ambient temperature of +50 °C

²⁾ Assigned motor rating for normal internally and externally ventilated four-pole, three-phase asynchronous motors with 1500 rpm (at 50 Hz) or 1800 rpm (at 60 Hz)

Information relevant for export to North America

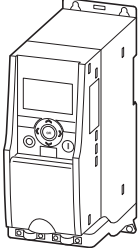

Product Standards	UL 508C; CSA-C22.2 No. 14; IEC/EN61800-3; IEC/EN61800-5; CE marking
UL File No.	E134360
UL CCN	NMMS, NMMS7
CSA File No.	UL report applies to both US and Canada
CSA Class No.	3211-06
NA Certification	UL Listed, certified by UL for use in Canada
Suitable for	Branch circuits
Max. Voltage Rating	1~ 240 V AC IEC: TN-S UL/CSA: "Y" (Solidly Grounded Wey)
Degree of Protection	IEC: IP20; optionally UL/CSA NEMA 1

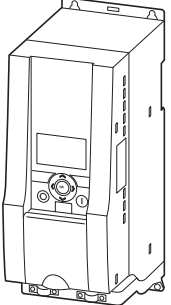
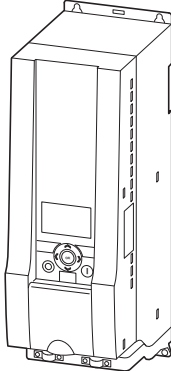
	Rated operational current frequency inverter ¹⁾	Assigned motor rating (50/60 Hz) ²⁾	Rated operational current motor	With internal radio interference suppression filter	Price See price list	Std. pack	Without internal radio interference suppression filter	Price See price list	Std. pack
	I_e A	P kW	I_e A	Part no. Article no.			Part no. Article no.		
Rated operational voltage 3 AC 230 V									
	1.7	0.25	1.4	MMX32AA1D7F0-0 121390		1 off  	MMX32AA1D7N0-0 122667		1 off  
	2.4	0.37	2	MMX32AA2D4F0-0 121391			MMX32AA2D4N0-0 122668		
	2.8	0.55	2.7	MMX32AA2D8F0-0 121392			MMX32AA2D8N0-0 122669		
	3.7	0.75	3.2	MMX32AA3D7F0-0 121393			MMX32AA3D7N0-0 122670		
	4.8	1.1	4.6	MMX32AA4D8F0-0 121394			MMX32AA4D8N0-0 122671		
	7	1.5	6.3	MMX32AA7D0F0-0 121395			MMX32AA7D0N0-0 122672		
	9.6	2.2	8.7	MMX32AA011F0-0 121396			MMX32AA011N0-0 122673		

Notes

¹⁾ Rated operational current at an operating frequency of 6 kHz and an ambient temperature of +50 °C





²⁾ Assigned motor rating for normal internally and externally ventilated four-pole, three-phase asynchronous motors with 1500 rpm (at 50 Hz) or 1800 rpm (at 60 Hz)

Information relevant for export to North America

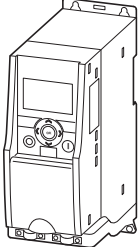

Product Standards	UL 508C; CSA-C22.2 No. 14; IEC/EN61800-3; IEC/EN61800-5; CE marking
UL File No.	E134360
UL CCN	NMMS, NMMS7
CSA File No.	UL report applies to both US and Canada
CSA Class No.	3211-06
NA Certification	UL Listed, certified by UL for use in Canada
Suitable for	Branch circuits
Max. Voltage Rating	1~ 240 V AC IEC: TN-S UL/CSA: "Y" (Solidly Grounded Wey)
Degree of Protection	IEC: IP20; optionally UL/CSA NEMA 1

HPL10007EN

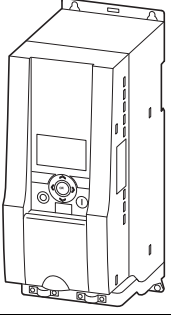
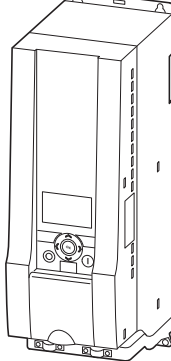
	Rated operational current frequency inverter ¹⁾	Assigned motor rating (50/60 Hz) ²⁾	Rated operational current motor	With internal radio interference suppression filter	Price See price list	Std. pack	Without internal radio interference suppression filter	Price See price list	Std. pack
	I_e A	P kW	I_e A	Part no. Article no.			Part no. Article no.		
Rated operational voltage 3 AC 400 V									
	1.3	0.37	1.1	MMX34AA1D3F0-0 121397	1 off  	MMX34AA1D3N0-0 122674	1 off  		
	1.9	0.55	1.5	MMX34AA1D9F0-0 121398				MMX34AA1D9N0-0 122675	
	2.4	0.75	1.9	MMX34AA2D4F0-0 121399				MMX34AA2D4N0-0 122676	
	3.3	1.1	2.6	MMX34AA3D3F0-0 121400				MMX34AA3D3N0-0 122677	
	4.3	1.5	3.6	MMX34AA4D3F0-0 121401				MMX34AA4D3N0-0 122678	
	5.6	2.2	5	MMX34AA5D6F0-0 121402				MMX34AA5D6N0-0 122679	
	7.6	3	6.6	MMX34AA7D6F0-0 121403				MMX34AA7D6N0-0 122680	
	9	4	8.5	MMX34AA9D0F0-0 121404				MMX34AA9D0N0-0 122681	
	12	5.5	11.3	MMX34AA012F0-0 121405				MMX34AA012N0-0 122682	
	14	7.5	15.2	MMX34AA014F0-0 122684				MMX34AA014N0-0 122683	

Notes

¹⁾ Rated operational current at an operating frequency of 6 kHz and an ambient temperature of +50 °C

²⁾ Assigned motor rating for normal internally and externally ventilated four-pole, three-phase asynchronous motors with 1500 rpm (at 50 Hz) or 1800 rpm (at 60 Hz)

Information relevant for export to North America



Product Standards	UL 508C; CSA-C22.2 No. 14; IEC/EN61800-3; IEC/EN61800-5; CE marking
UL File No.	E134360
UL CCN	NMMS, NMMS7
CSA File No.	UL report applies to both US and Canada
CSA Class No.	3211-06
NA Certification	UL Listed, certified by UL for use in Canada
Suitable for	Branch circuits
Max. Voltage Rating	1~ 240 V AC IEC: TN-S UL/CSA: "Y" (Solidly Grounded Wey)
Degree of Protection	IEC: IP20; optionally UL/CSA NEMA 1

System overview

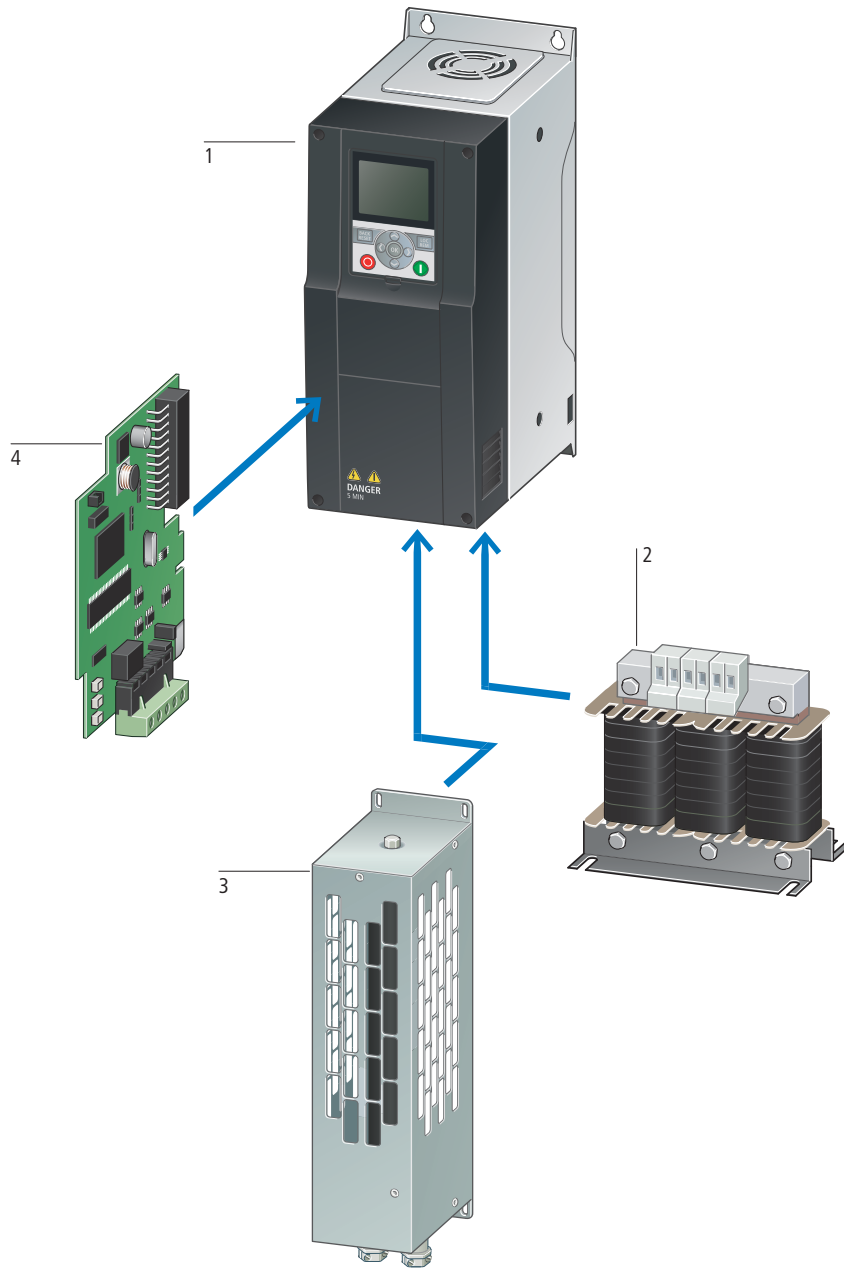

Basic device

Frequency inverters	1
HMX32... Mains: 3-phase, 230/240 V Assigned motor rating from 0.75 to 90 kW (230 V) → Page 10/10	
HMX34... Mains: 3-phase, 400/480 V Assigned motor rating from 1.1 to 160 kW (400 V) → Page 10/12	

System accessories

Communication module	4
Versions <ul style="list-style-type: none"> • CANopen fieldbus connection • PROFIBUS DP fieldbus connection • DeviceNet fieldbus connection → Page 10/18	

Accessories

Motor chokes	2
→ Page 10/21	
Braking resistor	3
→ Page 10/17	

Description



Application

H-Max™ frequency inverters are specially suitable for continuously variable speed control of three-phase asynchronous motors in heating, ventilation and air conditioning (HVAC) applications. A comprehensive range of control and function modules allow an automatic changeover in applications with several motors, cascade and bypass controllers and direct control of non-stabilized motors.

The devices of the H-Max™ series support energy-optimized applications with fluid flow machines (pumps, fans). They allow the PID controllers to maintain a constant conveying pressure in booster stations regardless of throughput. A fire control ensures reliable operation of pumps in sprinkler systems.

The network protocols relevant for HVAC applications – BACNet and Modbus – are included onboard as standard in two versions (RS485, Ethernet).

With this comprehensive range of setting options, ease of handling is important. The frequency inverters are preset for the assigned motor rating and can be taken into operation without any parameterization required. A clear, comprehensive graphic display shows all relevant drive parameters. Two enclosure versions with IP21 and IP54 protection types are available for individual installation.

For the operation of standard three-phase asynchronous motors the devices supply rated operational currents of 3.4 to 310 A for assigned shaft ratings of:

- 0.75 to 90 kW at 230 V (three-phase mains connection),
- 1.1 to 160 kW at 400 V (three-phase mains connection).

Features

- Compact design through state-of-the-art IGBT modules
- Integrated radio interference suppression filter (EMC)
- Integrated DC link choke
- Plug-in keypad with backlit graphic LCD display
- 6 digital inputs (24 V DC) for sink- and source-type control
- 3 relays (2 changeover contacts, 1 N/O, 230 V) on a plug-in card, can be replaced with other relay configurations or additional digital and analog inputs and outputs
- 2 analog inputs (0 to +10 V, 4 to 20 mA), selectable and scaleable
- 1 analog output (0 to +10 V), scaleable
- 1 serial interface (RS485, Modbus RTU)
- Internal braking transistor
- 2 slots for optional fieldbus connection (CANopen, PROFIBUS-DP, DeviceNet, LonWorks)
- User-friendly commissioning through fast configuration and application menu
- Compliance with global standards to CE, UL, c-UL and c-Tick

Functions

A comprehensive range of protection functions allow safe operation and the protection of frequency inverter, motor and application. They offer protection against:

- Overcurrent, ground fault
- Overload (electronic motor protection), underload, dry running
- Overtemperature
- Overvoltage, undervoltage

Further functions are:

- Flying restart circuit
- Thermistor protection
- Restart interlock, automatic restart
- Actual/reference value monitoring
- U/f control or sensorless vector control
- Double starting current and 1.1 times overcurrent
- 2 PID controllers
- Sequencing, multi-motor and bypass control, cascading
- Fire control
- Automatic sleep and wake-up function
- Timer function (day/time control)
- Braking control
- DC braking before start and up to motor standstill
- 8 fixed frequencies
- Electronic motor potentiometer
- Logic function (AND, OR, XOR)
- Upper and lower frequency and current limits
- Frequency hopping (frequency masking)
- 2 parameter sets









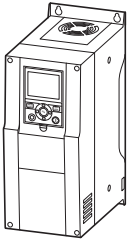

Documentation

An instructional leaflet and a CD are included with each frequency inverter of the H-Max™ series.

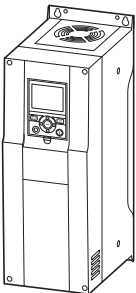
The instructional leaflet is a quick guide with illustrations and notes in 23 languages about the correct handling, mounting and electrical connection of the device. The CD contains the instructional leaflet as well as the Hardware and Engineering manual in several languages. The current documentation is also available for download from www.moeller.net/support

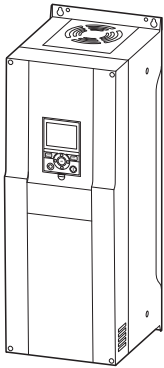

Ordering

	Rated operational current of frequency inverter ¹⁾	Assigned motor rating (50/60 Hz) ²⁾	Rated operational current motor	Part no. Article no.	Price See price list	Std. pack	Part no. Article no.	Price See price list	Std. pack
	I _e A	P kW	I _e A						
Rated operational voltage 3 AC 230 V									
	3.7	0.55	2.7	HMX32AG3D721-B 127151		1 off  	HMX32AG3D722-B 127170		1 off  
	4.8	0.75	3.2	HMX32AG4D821-B 127152			HMX32AG4D822-B 127171		
	6.6	1.1	4.6	HMX32AG6D621-B 127153			HMX32AG6D622-B 127172		
	8	1.5	6.3	HMX32AG8D021-B 127154			HMX32AG8D022-B 127173		
	11	2.2	8.7	HMX32AG01121-B 127155			HMX32AG01122-B 127174		
	12.5	3	11.5	HMX32AG01221-B 127156		1 off  	HMX32AG01222-B 127175		1 off  
	18	4	14.8	HMX32AG01821-B 127157			HMX32AG01822-B 127176		
	24.2	5.5	19.6	HMX32AG02421-B 127158			HMX32AG02422-B 127177		
	31	7.5	26.4	HMX32AG03121-B 127159			HMX32AG03122-B 127178		
		48	11	38	HMX32AG04821-B 127160			1 off  	
62		15	51	HMX32AG06221-B 127161		HMX32AG06222-B 127180			

Notes





¹⁾ Rated operational current at an operating frequency of 6 kHz and an ambient temperature of +40 °C

²⁾ Assigned motor rating for normal internally and externally ventilated four-pole, three-phase asynchronous motors with 1500 rpm (at 50 Hz) or 1800 rpm (at 60 Hz)

Information relevant for export to North America



Product Standards	UL 508C; CSA-C22.2 No. 14; IEC/EN61800-3; IEC/EN61800-5; CE marking
NA Certification	Request filed for UL and CSA
Suitable for	Branch circuits
Max. Voltage Rating	3~ 240 V AC IEC: TN-S UL/CSA: "Y" (Solidly Grounded Wey)
Degree of Protection	IEC: IP21; UL/CSA NEMA 1

Rated operational current of frequency inverter ¹⁾	Assigned motor rating (50/60 Hz) ²⁾	Rated operational current motor	With internal radio interference suppression filter, protection type IP21			With internal radio interference suppression filter, protection type IP54		
			Part no. Article no.	Price See price list	Std. pack	Part no. Article no.	Price See price list	Std. pack
I _e A	P kW	I _e A						
Rated operational voltage 3 AC 230 V								
77	18.5	63	HMX32AG07721-B 127162		1 off  	HMX32AG07722-B 127181		1 off  
88	22	71	HMX32AG08821-B 127163			HMX32AG08822-B 127182		
106	30	96	HMX32AG10621-B 127164			HMX32AG10622-B 127183		
143	45	117	HMX32AG14321-B 127165			HMX32AG14322-B 127184		
170	45	141	HMX32AG17021-B 127166			HMX32AG17022-B 127185		
208	55	173	HMX32AG20821-B 127167			HMX32AG20822-B 127186		
261	75	233	HMX32AG26121-B 127168			HMX32AG26122-B 127187		
310	90	279	HMX32AG31021-B 127169			HMX32AG31022-B 127188		

Notes

¹⁾ Rated operational current at an operating frequency of 6 kHz and an ambient temperature of +40 °C



²⁾ Assigned motor rating for normal internally and externally ventilated four-pole, three-phase asynchronous motors with 1500 rpm (at 50 Hz) or 1800 rpm (at 60 Hz)

Information relevant for export to North America



Product Standards	UL 508C; CSA-C22.2 No. 14; IEC/EN61800-3; IEC/EN61800-5; CE marking
NA Certification	Request filed for UL and CSA
Suitable for	Branch circuits
Max. Voltage Rating	3~ 240 V AC IEC: TN-S UL/CSA: "Y" (Solidly Grounded Wey)
Degree of Protection	IEC: IP21; UL/CSA NEMA 1

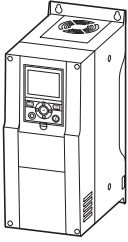

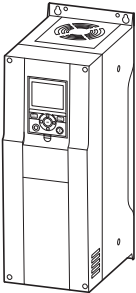
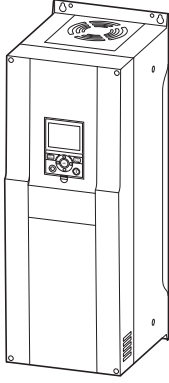
	Rated operational current of frequency inverter ¹⁾	Assigned motor rating (50/60 Hz) ²⁾	Rated operational current Motor	Part no. Article no.	Price See price list	With integrated radio interference suppression filter Protection type IP21	Part no. Article no.	Price See price list	With integrated radio interference suppression filter Protection type IP54	Std. pack
	I _e A	P kWh	I _e A							
Rated operational voltage 3 AC 400 V										
	3.4	1.1	2.1	HMX34AG3D421-B 126928			HMX34AG3D422-B 126958			1 off  
	4.8	1.5	3.6	HMX34AG4D821-B 126929			HMX34AG4D822-B 126959			
	5.6	2.2	5	HMX34AG5D621-B 126940			HMX34AG5D622-B 126960			
	8	3	6.6	HMX34AG8D021-B 126941			HMX34AG8D022-B 126961			
	9.6	4	8.5	HMX34AG9D621-B 126942			HMX34AG9D622-B 126962			
	12	5.5	11.3	HMX34AG01221-B 126943			HMX34AG01222-B 126963			
	16	7.5	15.2	HMX34AG01621-B 126944			HMX34AG01622-B 126964			
	23	11	21.7	HMX34AG02321-B 126945			HMX34AG02322-B 126965			
	31	15	29.3	HMX34AG03121-B 126946			HMX34AG03122-B 126966			
	38	18.5	36	HMX34AG03821-B 126947			HMX34AG03822-B 126967			
	46	22	41	HMX34AG04621-B 126948			HMX34AG04622-B 126968			
	61	30	55	HMX34AG06121-B 126949			HMX34AG06122-B 126969			
	72	37	68	HMX34AG07221-B 126950			HMX34AG07222-B 126970			
	87	45	81	HMX34AG08721-B 126951			HMX34AG08722-B 126971			
	105	55	99	HMX34AG10521-B 126952			HMX34AG10522-B 126972			
	140	75	134	HMX34AG14021-B 126953			HMX34AG14022-B 126973			
	170	90	161	HMX34AG17021-B 126954			HMX34AG17022-B 126974			
	205	110	196	HMX34AG20521-B 126955			HMX34AG20522-B 126975			
261	132	231	HMX34AG26121-B 126956			HMX34AG26122-B 126976				
310	160	279	HMX34AG31021-B 126957			HMX34AG31022-B 126977				

Notes

¹⁾ Rated operational current at an operating frequency of 6 kHz and an ambient temperature of +40 °C

²⁾ Assigned motor rating for normal internally and externally ventilated four-pole, three-phase asynchronous motors with 1500 rpm (at 50 Hz) or 1800 rpm (at 60 Hz)

Information relevant for export to North America



Product Standards
NA Certification
Suitable for
Max. Voltage Rating
Degree of Protection

UL 508C; CSA-C22.2 No. 14; IEC/EN61800-3; IEC/EN61800-5; CE marking
Request filed for UL and CSA
Branch circuits
3~ 480 V AC IEC: TN-S UL/CSA: "Y" (Solidly Grounded Wey)
IEC: IP21; UL/CSA NEMA 1

Description

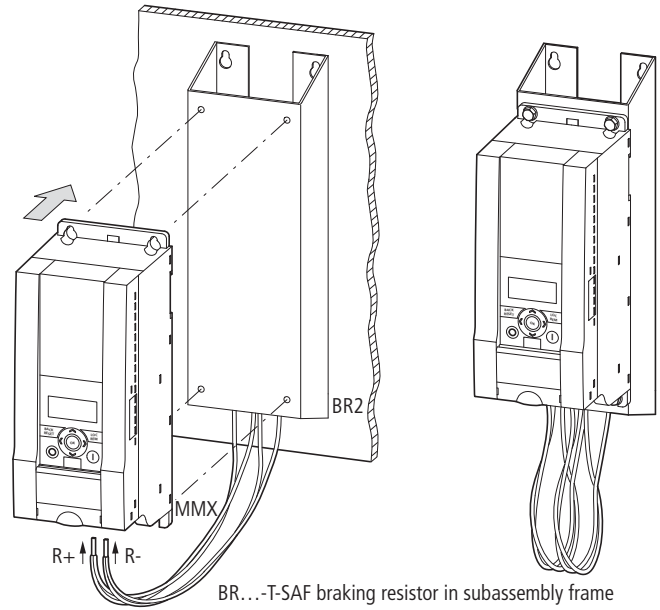

BR...-T-SAF braking resistor in subassembly frame

Type overview

BR1...-T-PF, BR3...-T-PF

Braking resistors

Application

An external braking resistor is required for braking larger moments of inertia or for prolonged regenerative operation. This converts the motor's mechanical braking energy into heat.

Features

These resistors are built into a perforated metal sheet enclosure and equipped with a thermostatic circuit-breaker (230 V, 1 A, AC-1). The enclosures are made of galvanized sheet metal and are open at the bottom. They fulfil protection type IP65 only in their fitted state.

With a combination of several series- and parallel-connected resistors, a higher braking power can be achieved. The braking resistors can be connected directly to the brake choppers of MMX34... frequency inverters.

Function

The frequency inverter's built-in braking transistor automatically switches in the connected braking resistor as soon as the internal DC link voltage exceeds the switching threshold. This prevents excessive voltages on the internal DC link, which would otherwise cause an overvoltage fault message and the frequency inverter's pulse inhibitor to be set. The drive then coasts to a halt uncontrolled.

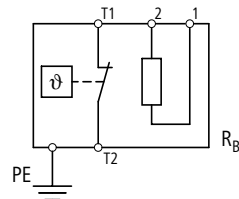

Documentation

The documentation can also be obtained on the Internet from: www.moeller.net/support

Type overview

BR2..., BR2...-T-SAF

Braking resistors

Features

BR2... is a short-circuit proof, intrinsically safe braking resistor in an anodized aluminum enclosure with protection type IP65 and without a thermostat.



Note: When used according to UL directives, the rating data for continuous braking and the maximum pulse performance must be reduced by 25%.

Caution: The surface temperature can exceed 100 °C!

- BR2...-T-SAF is a combination of several braking resistors BR2... braking resistors with a thermostat. They are built into a subassembly frame for the M-Max™ frequency inverters.
- BR1...-T-PF is a braking resistor or a combination of several braking resistors with a thermostat. It is installed in an encapsulated enclosure with protection type IP54 and protected against accidental contact.
- BR3...-T-PF is a braking resistor in a steel mesh design with a thermostat. It is installed in an encapsulated enclosure with protection type IP54 and protected against accidental contact.
- ...-T = with a thermostat
- ...-SAF = subassembly frame
- ...-PF = protection frame (protects against accidental contact)





Type overview

MMX-COM-PC

PC connection for the frequency inverters of M-Max™ series

Application

MMX-COM-PC allows communication and data transfer between a frequency inverter and a PC.

The parameters can also be copied directly between frequency inverters of the same device series without a PC connection. If a battery (9 V block) is fitted, mains power supply is also not required for this.

Features

The MMX-COM-PC communication module is plugged in at the front of M-Max™ frequency inverters.

The connection cable included as standard (length: 3.2 m) with an isolated interface converter allows connection to a PC with a USB port. This communication module can help increase data security and cut commissioning and maintenance times:

- Online parameterization and monitoring display (oscilloscope) on a PC; on a connected printer parameter lists and monitor displays can also be printed out
- Upload and download of all parameters
- Parameter backup and comparison
- Parameter copy function (e.g. for series machines or for device replacement)

Documentation

Instructional leaflet AWA8240-2428 (included as standard with each card)
Documentation available for download at www.moeller.net/support

Type overview

XMX-NET-DN-A

DeviceNet fieldbus connection for the frequency inverters of the M-Max™ and H-Max™ series

Application

XMX-NET-DN-A allows the connection as slave of the M-Max™ and H-Max™ frequency inverters to the standard DeviceNet field bus.

The fieldbus connection is implemented via pluggable 5-pole screw terminals with the XMX-NET-PS-A and a 9-pole SUB-D connector with the XMX-NET-PD-A.

Features

On the H-Max™ frequency inverters, interface card XMX-NET-DN-A is slotted into the housing.

On M-Max™ frequency inverters, mounting frame MMX-NET-XA is required. Here the interface card is connected via a plug-in connector on the right side of the frequency inverter.

Technical data:

- Communication protocol: CAN
- Data transfer: ODVA 2.0 compliant
- Transfer rate (adjustable): 125, 250 and 500 Kbit/s
- Maximum cable length, depending on transfer rate: 125 Kbits/s → 500 m, 250 Kbits/s → 250 m, 500 Kbit/s → 100 m
- Network supply: 11 to 25 V DC, 28 mA (typical), peak inrush current 125 mA
- Addressing (adjustable): to 64 (nodes)
- Status indication via LEDs

Documentation

Documentation available for download at www.moeller.net/support



CANopen

Type overview

XMX-NET-CO-A

CANopen connection for the frequency inverters of the M-Max™ and H-Max™ series

Application

XMX-NET-CO-A allows the connection as slave of the M-Max™ and H-Max™ frequency inverters to the standard CANopen field bus. They are connected to the field bus through 5-pole screw terminals.

Features

On the H-Max™ frequency inverters, the XMX-NET-CO-A interface card is slotted into the housing.

On M-Max™ frequency inverters, mounting frame MMX-NET-XA is required. Here the interface card is connected via a plug-in connector on the right side of the frequency inverter.

Technical data:

- Communications protocol: CiA DS-301,
- CiA-DSP-402
- Data transfer: CAN (ISO 11898)
- Transfer rate (adjustable): 10 Kbits/s up to 1 Mbit/s
- Maximum cable length, depending on transfer rate (without amplifier):
- 30 m up to 2.5 km
- Addressing (adjustable): 1 - 127
- Status indication via LEDs

Documentation

Instructional leaflet AWA8240-2426 (included as standard with each card)
Manual AWB8240-1632
Documentation available for download at www.moeller.net/support

Type overview

XMX-NET-PD-A, XMX-NET-PS-A

PROFIBUS-DP connection for the frequency inverters of the M-Max™ and H-Max™ series

Application

XMX-NET-DP-... allows the connection as slave of the M-Max™ and H-Max™ frequency inverters to the standard PROFIBUS-DP field bus. The XMX-NET-PS-A is connected to the field bus through 5-pole plug-in screw terminals and XMX-NET-PD-A through a 9-pin Sub-D connector.

Features

On the H-Max™ frequency inverters, the XMX-NET-DP-... interface card is slotted into the housing.

On M-Max™ frequency inverters, mounting frame MMX-NET-XA is required. Here the interface card is connected via a plug-in connector on the right side of the frequency inverter.

Technical data:

- Communication protocol: Profidrive (PROFIBUS profile for variable-speed drives)
- Data transfer: RS485, half-duplex
- PPO type: 1, 2, 3, 4, 5
- Transfer rate (adjustable): 9.6 Kbits/s up to 12 Mbit/s
- Maximum cable length, depending on transfer rate (without amplifier): 100 m up to 1.2 km
- Addressing (adjustable): 2 - 126
- Status indication via LEDs

Documentation

Instructional leaflet AWA8240-2427 (included as standard with each card)
Documentation available for download at www.moeller.net/support



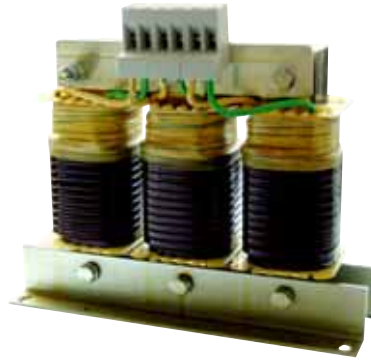

Type overview

DEX-LN1...

Mains chokes, single-phase

DEX-LN3...

Mains chokes, three-phase

Application

Mains chokes (also called mains chokes) are connected in series on the mains side of electronic devices, such as frequency inverters.

Features

The DEX-LN... line reactors are vacuum-impregnated. Their air gaps are therefore bridged with a low-fatigue, metallic and magnetically neutral connection, which reduces noise emission.

Note: Because of the flux distribution caused by their physical design, motor chokes should be installed at a distance of at least 50 mm from metal parts and adjacent subassemblies.

Functions

Mains chokes attenuate any current harmonics and peaks and limit the starting current (internal DC link capacitors). Through the reduction of current harmonics, the r.m.s. value of the absorbed current can be reduced by up to 30 percent. In addition, mains chokes permit a short-circuit voltage to the mains (u_k value) of about four percent, which is often required. Mains chokes also extend the lifespan of components (rectifier diodes, DC link capacitors) in devices with an input-side internal DC link (frequency inverters, USPs).

Documentation

Every line reactor is supplied with an instructional leaflet (AWA 8240-1711). The documentation is also available for download from www.moeller.net/support

Type overview

DEX-LM3...

Motor chokes, three-phase

Application

Motor chokes are connected in series to the output of frequency inverters.

Features

The DEX-LM3... motor chokes are vacuum-impregnated. Their air gaps are therefore bridged with a low-fatigue, metallic and magnetically neutral connection, which reduces noise emission.

Motor chokes have larger dimensions than comparable mains chokes with the same rated operational current.

Note: Because of the flux distribution caused by their physical design, motor chokes should be installed at a distance of at least 50 mm from metal parts and adjacent subassemblies.

Functions

Motor chokes reduce the edge gradient of the output voltage ($du/dt < 500$ V/ms) of a frequency inverter. They also reduce the motor's noise emission and heat generation. Through the use of motor chokes the permissible motor cable length can be increased to up to 200 meters. When operating several motors in parallel at the output of a single frequency inverter, the use of motor chokes is recommended, as they attenuate the high capacitive reactive currents.

Documentation

Every motor choke is supplied with an instructional leaflet (AWA 8240-1711). The documentation is also available for download from www.moeller.net/support

HPL10017EN

BR...

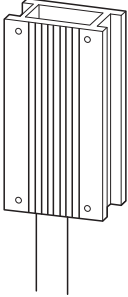
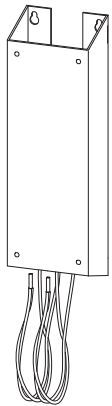
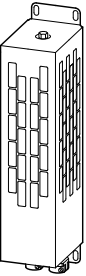
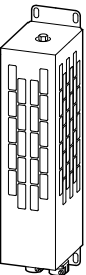
	Braking resistance	Continuous braking power	For use with	Part no. Article no.	Price See price list	Std. pack
	R Ω	P _{DB} W				
Braking resistors						
Protection type IP65						
Short-circuit proof, intrinsically safe braking resistor in anodized aluminum enclosure, with thermostat						
	47	240	MMX34...	BR2047240 140434		1 off
	60	200	MMX34...	BR2060200 140433		1 off
Short-circuit proof, intrinsically safe braking resistor with thermostat, with mounting frame for base (footprint) mounting						
	36	400	MMX34...	BR2036400-T-SAF 140437		1 off
	47	240	MMX34...	BR2047240-T-SAF 140436		
	60	200	MMX34...	BR2060200-T-SAF 140435		
	65	400	MMX34...	BR2065400-T-SAF 140438		
	75	480	MMX34...	BR2075480-T-SAF 140439		
Protection type IP54						
	36	2450	MMX34...	BR30362K4-T-PF 141325		1 off
	36	2800	MMX34...	BR30362K8-T-PF 141326		
	36	3600	MMX34...	BR30363K6-T-PF 141327		
Protection type IP54						
	36	500	MMX34...	BR1036500-T-PF 141323		1 off
	36	1000	MMX34...	BR10361K0-T-PF 141324		
	56	300	MMX34...	BR1056300-T-PF 141320		
	56	800	MMX34...	BR1056800-T-PF 141321		
	56	1000	MMX34...	BR10561K0-T-PF 141322		

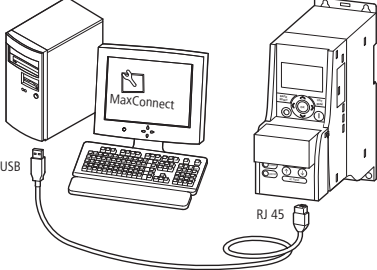
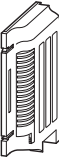
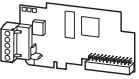
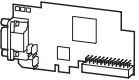
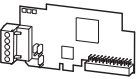
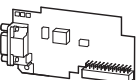
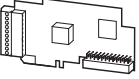

		Part no. Article no.	Price See price list	Std. pack	Notes	
Interface cards						
For use with MMX...						
PC connection (USB/RJ45) for the frequency inverters of M-Max series <ul style="list-style-type: none"> With 3.2 m connection cable and interface converter Data transfer with PC software and copy function (retentive memory) between MMX... frequency inverters 		MMX-COM-PC 121406		1 off		
						
 Mounting frame for XMX-NET... fieldbus interface cards On M-Max™ frequency inverters		MMX-NET-XA 134510		1 off	Mounting frame for side connection to M-Max™ frequency inverters	
For use with MMX... und HMX...		Description	Part no. Article no.	Price See price list	Std. pack	Notes
Fieldbus connection						
	CANopen	Connection through plug-in screw terminals The interface card is slotted into the device.	XMX-NET-CO-A 134511		1 off	Mounting frame MMX-NET-XA required for M-Max™
	PROFIBUS-DP (Screw terminal)	Connection through plug-in screw terminals The interface card is slotted into the device.	XMX-NET-PS-A 136556			
	PROFIBUS-DP (Sub D)	Connection through Sub-D plug The interface card is slotted into the device.	XMX-NET-PD-A 136557			
	PROFINET	The interface card is slotted into the device.	XMX-NET-PN-A 138237			
	DeviceNet	The interface card is slotted into the device.	XMX-NET-DN-A 136558			
	LON	The interface card is slotted into the device.	XMX-NET-LO-A 138238			
Plug-in modules						
For use with HMX...						
	Digital I/O card	6 digital input (24 V DC) 6 digital outputs (transistor, 24 - 48 V DC) 24 V supply	XMX-IO-B1-A 138239		1 off	–
	Relay/thermistor card	1 relay (changeover contact, N/O/NC, 250 V, 2 A) 1 relay (normally open contact, N/O, 250 V, 2 A) 1 thermistor input	XMX-IO-B2-A 138240			–
	Analog I/O card	1 analog input (0 -+ 10 V, 4 - 20 mA) 2 analog outputs (0 -+ 10 V, 4 - 20 mA)	XMX-IO-B4-A 138241			–
	Relay card	3 relays (normally open contact, N/O, 250 V, 2 A)	XMX-IO-B5-A 138242			–
	PT100 card	3 PT 100 thermistor inputs 24 V supply	XMX-IO-B8-A 138243			–
	Digital input/relay card	1 relay (normally open contact, N/O, 250 V, 2 A) 5 digital inputs (42 - 240 V AC)	XMX-IO-B9-A 138244			–
	Output card	1 relay (normally open contact, N/O, 250 V, 2 A) 1 digital output (transistor, 24 - 48 V DC) 1 analog output (0 -+ 10 V, 4 - 20 mA)	XMX-IO-BF-A 138245			–

HPL10019EN

Input current I_{LN} A	For use with	Part no. Article no.	Price See price list	Std. pack	Notes
Radio interference suppression filters, single-phase					
Maximum mains voltage U_{LN} : 240 + 10 % V (50/60 Hz)					
9	MMX12AA1D7... MMX12AA2D4... MMX12AA2D8... MMX12AA3D7...	MMX-LZ1-009 138231		1 off	For mounting next to or underneath the MMX... for size FS1
15	MMX12AA4D8... MMX12AA7D0...	MMX-LZ1-015 138232		1 off	For mounting next to or underneath the MMX... for size FS2
17	MMX12AA9D6...	MMX-LZ1-017 138233		1 off	For mounting next to or underneath the MMX... for size FS3
Radio interference suppression filters, three-phase					
Maximum mains voltage U_{LN} : 480 + 10 % V (50/60 Hz)					
	6	MMX32AA1D7... MMX32AA2D4... MMX32AA2D8... MMX32AA3D7... MMX34AA1D3... MMX34AA1D9... MMX34AA2D4... MMX34AA3D3...	MMX-LZ3-006 138234	1 off	For mounting next to or underneath the MMX... for size FS1
	9	MMX32AA4D8... MMX32AA7D0... MMX34AA4D3... MMX34AA5D6...	MMX-LZ3-009 138235	1 off	For mounting next to or underneath the MMX... for size FS2
	22	MMX32AA9D6... MMX34AA7D6... MMX34AA9D0... MMX34AA012... MMX34AA014...	MMX-LZ3-020 138236	1 off	For mounting next to or underneath the MMX... for size FS3

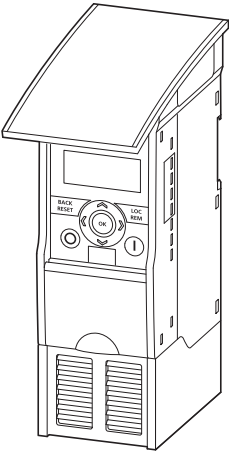

	For use with	Part no. Article no.	Price See price list	Std. pack
Enclosure accessories				
Increased protection type IP21/NEMA 1, two-part enclosure cover with cable retention clip for EMC-conformant connection				
	For size FS1	MMX12AA1D7... MMX12AA2D4... MMX12AA2D8... MMX32AA1D7... MMX32AA2D4... MMX32AA2D8... MMX34AA1D3... MMX34AA1D9... MMX34AA2D4...	MMX-IP21-FS1 121407	1 off
	For size FS2	MMX12AA3D7... MMX12AA4D8... MMX12AA7D0... MMX32AA3D7... MMX32AA4D8... MMX32AA7D0... MMX34AA3D3... MMX34AA4D3... MMX34AA5D6...	MMX-IP21-FS2 121408	1 off
	For size FS3	MMX12AA9D6... MMX32AA9D6... MMX34AA7D6... MMX34AA9D0... MMX34AA012... MMX34AA014...	MMX-IP21-FS3 121409	1 off

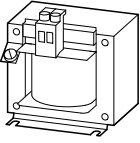
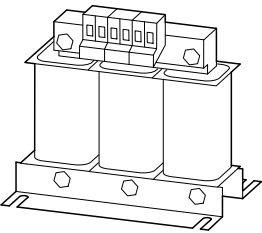
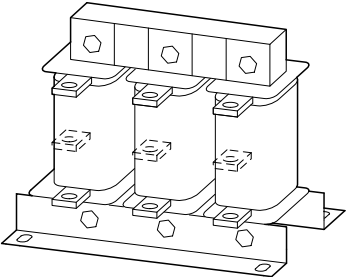
	Rated operational current	Inductance	Max. heat dissipation	Part no. Article no.	Price See price list	Std. pack
	I_e A	L mH	P_v W			
Mains chokes, single-phase						
Max. permissible mains voltage: 260 V +0 % (50/60 Hz)						
	5.8	5.05	9	DEX-LN1-006 269490		1 off
	8.6	3.41	11	DEX-LN1-009 269495		
	13	2.25	12	DEX-LN1-013 269496		
	18	1.63	17	DEX-LN1-018 269497		
	24	1.22	20	DEX-LN1-024 269498		
Mains chokes, three-phase						
Max. permissible mains voltage: 550 V +0 % (50/60 Hz)						
	3.9	7.51	17	DEX-LN3-004 269500		1 off
	6	4.9	19	DEX-LN3-006 269501		
	10	2.94	33	DEX-LN3-010 269502		
	16	1.84	44	DEX-LN3-016 269503		
	25	1.18	57	DEX-LN3-025 269504		
	40	0.64	59	DEX-LN3-040 269505		
	50	0.37	58	DEX-LN3-050 269506		
	60	0.31	60	DEX-LN3-060 269507		
	80	0.23	86	DEX-LN3-080 269508		
	100	0.18	101	DEX-LN3-100 269509		
	120	0.15	100	DEX-LN3-120 269510		
	160	0.11	140	DEX-LN3-160 269511		
	200	0.09	154	DEX-LN3-200 269512		
	250	0.07	155	DEX-LN3-250 269513		
	300	0.06	169	DEX-LN3-300 269514		

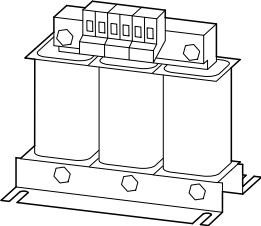
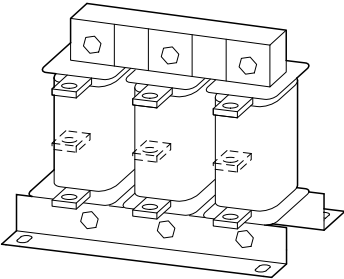
	Rated operational current	Inductance	Max. heat dissipation at 12 kHz	Part no. Article no.	Price See price list	Std. pack
	I_e A	L mH	P_v W			
Motor chokes, three-phase						
Max. permissible mains voltage: 750 V +0 % (50/60 Hz)						
	5	2	24	DEX-LM3-005 269538		1 off
	8	4.1	54	DEX-LM3-008 269539		
	11	3	71	DEX-LM3-011 269541		
	16	1.5	78	DEX-LM3-016 269542		
	35	1	116	DEX-LM3-035 269543		
	50	0.6	168	DEX-LM3-050 269544		
	63	0.5	193	DEX-LM3-063 269545		
	80	0.5	206	DEX-LM3-080 269546		
	100	0.45	294	DEX-LM3-100 269547		
	150	0.35	424	DEX-LM3-150 269548		
	180	0.3	498	DEX-LM3-180 269549		
	220	0.2	517	DEX-LM3-220 269560		
	260	0.15	520	DEX-LM3-260 269561		



10/22 Frequency inverters

Key to part numbers

Series MMX

MMX32AA1D7F0-0 (example)

MMX	3	2	A	A	1D7	F	0	-	0
MMX	1	2	A	A	Variable code	F	0	-	0
	3	4				N			

MMX = Product family M-Max™

Number of phases

- 1 = Single-phase mains supply
- 3 = Three-phase mains supply

Voltage class

- 2 = 200 V (208 V -15 % to 240 V +10 %)
- 4 = 400 V (380 V -15 % to 480 V +10 %)

Version

- A = Software version

Display unit

- A = Display unit built-in

Rated operational current (in amperes)

- xDy = x,y A (digital; e.g. 1D7 = 1.7 A)
- 0xy = xy A

Radio interference suppression filters

- F = with integrated radio interference suppression filter (C2)
- N = without radio interference suppression filter

Protection type

- 0 = IP20 = NEMA 0

Optional module

- 0 = no module built in

Series HMX

HMX34AG3D421-B (example)

HMX	3	4	A	G	3D4	2	1	-	B
HMX	3	2	A	G	Variable code	2	1	-	B
		4					2		

HMX = Product family H-Max™

Number of phases

- 3 = Three-phase mains supply

Voltage class

- 2 = 200 V (208 V -15 % to 240 V +10 %)
- 4 = 400 V (380 V -15 % to 480 V +10 %)

Version

- A = Software version

Display unit

- G = Graphics

Rated operational current (in amperes)

- xDy = x,y A (digital; e.g. 3D4 = 3.4 A)
- xyz = xyz A

Radio interference suppression filter (built-in)

- 2 = C2

Protection type

- 1 = IP21 = NEMA 1
- 2 = IP54 = NEMA 2

Brake chopper

- B = Built-in brake chopper

Components of a Power Drives System (PDS)

Engineering

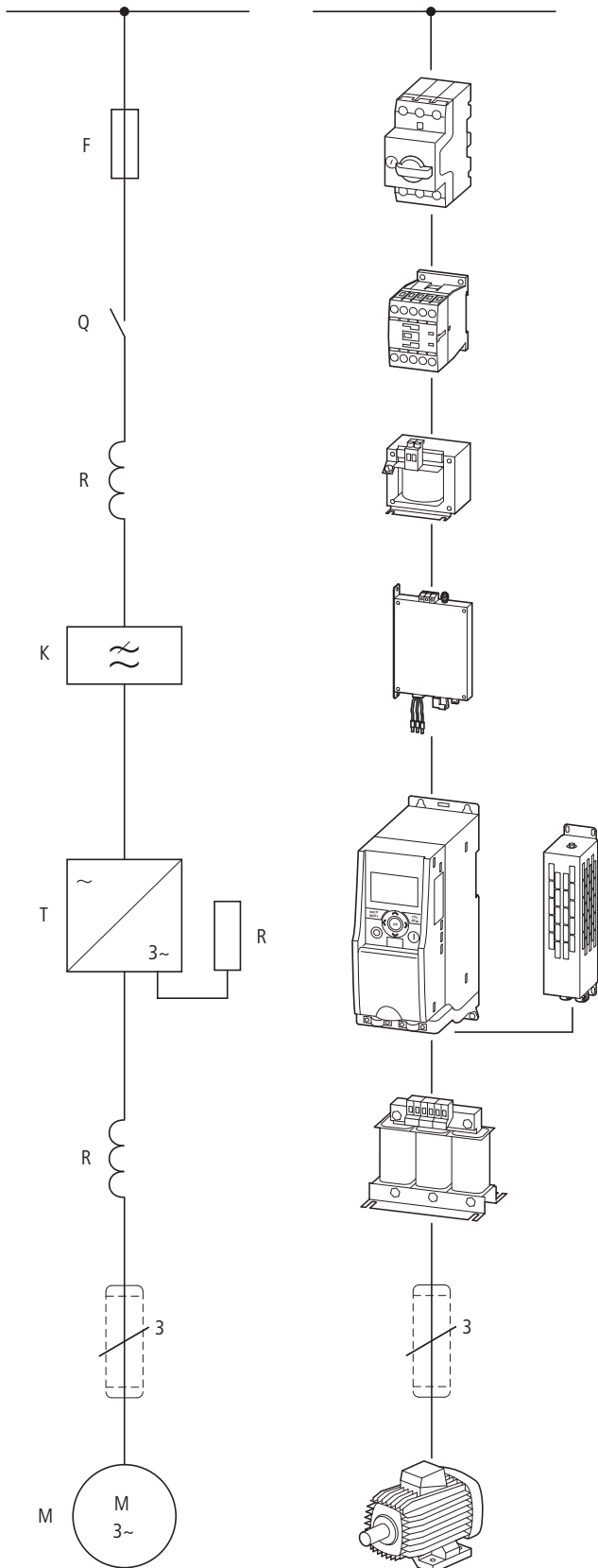

Item designations

- F = fuses and circuit-breakers
- Q = controlled switching within energy flow (contactors, circuit-breakers)
- R = limitation (reactors, chokes, resistors)
- K = radio interference suppression filters
- T = frequency inverters
- M = motors

Frequency inverters can be connected without limitation to AC supply systems with a grounded star point (TN and TT networks).

Fuses (circuit-breakers) allow the protection of lines and electrical apparatus. For personnel protection AC/DC-sensitive residual current devices (RCD Type B) are required in addition.

Contactors are used to switch mains voltage on and off.

Mains chokes attenuate any current harmonics and peaks and limit the inrush current (internal DC link capacitors).

Radio interference suppression filters attenuate high-frequency electromagnetic emissions from devices. They ensure that the EMC limit values for conducted interference specified in the applicable product standards are maintained (frequency inverters).

Frequency inverters allow a continuously variable speed control of three-phase motors.

A braking resistor convert the frequency inverter's regenerative braking energy into heat. The frequency inverter must be equipped with a brake chopper, which connects the braking resistor parallel to the internal DC link.

Motor chokes

- Compensate the capacitive reactive currents,
- Reduce current ripple and the motor's current change noise,
- Attenuate the retroaction on parallel connection of several motors.

Sine-wave filters

- Smoothen the output voltage sinusoidally,
- Reduce motor noise through du/dt reduction, and thereby increase the motor insulation's lifespan,
- Reduce the leakage currents to allow better motor performance at improved EMC values.

Shielded motor cables attenuate emitted and conducted high-frequency emissions within the limit values specified in the applicable product standard (EMC).

Three-phase asynchronous motor (standard motor)



Electrical mains connection

M-Max™ and H-Max™ frequency inverters can be connected and operated on star-point-grounded AC mains (according to IEC 60364) without limitation.

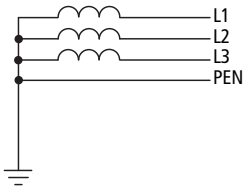
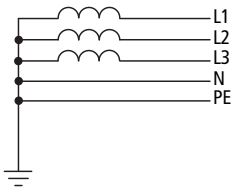

Connection and operation on asymmetrically grounded networks, such as phase-grounded delta (USA) or non-grounded or high-resistance-grounded (> 30 Ω) IT systems is permitted with limitations. In these networks only frequency inverters

Supply voltage U_{LN} of the utility company	Motor voltage according to UL 508 C	Consumer voltage, rated value for the motors
120 V	110 - 120 V	115 V
240 V	220 - 240 V	230 V
480 V	440 - 480 V	460 V
600 V	550 - 600 V	575 V

The wide tolerance band of the frequency inverters of the M-Max™ and H-Max™ series takes all known deviations from the standardized rated operational voltages worldwide into account (IEC 60038):

230 V: 208 V -15% - 240 V +10%

400 V: 380 V -15% - 480 V +10%

The permissible frequency range is 50 Hz -10% - 60 Hz +10%.

Safety and switching

The mains-side components are assigned according to the frequency inverter's input-side rated operational current I_{LN} and utilization category AC-1.

Fuses, circuit-breakers and conductor cross-sections must meet the national and regional requirements and the required approvals at the point of operation.

For fire prevention and the protection of persons and domestic animals from excessive contact voltages residual-current devices (RCD) must be used. In combination with a frequency inverter only AC/DC sensitive RCDs (Type B) must be used.

Identification on the residual-current circuit-breakers

AC/DC sensitive (RCD, type B)



With frequency-controlled power drive systems (PDS), leakage currents to ground occur. The main causes are external capacitances between the phases of the motor cable, the motor cable shielding, Y capacitors in the

without integrated radio interference suppression filters (EMC) must be used. On devices with integrated radio interference suppression filter the filter's ground connection must be disconnected.

The standardized rated operational voltages of the utility companies fulfill the following conditions at the point of transfer to the consumer:

- Maximum deviation from the rated voltage (U_{LN}): $\pm 10\%$
- Maximum deviation in the voltage symmetry: $\pm 3\%$
- Maximum deviation from the rated frequency: $\pm 4\%$

Regarding the lower voltage value ($U_{LN} - 10\%$) of the mains voltage, a further voltage drop of 4 percent in the consumer networks is permissible.

The power supply voltage at the consumer must have a value of $U_{LN} - 14\%$.

In ring-operated mesh networks (such as in the EU) the standardized consumer voltages (230/400/690 V) are identical with the utility company's supply voltages. In star networks (for example in North America/USA), the stated consumer voltages take the voltage drop from the utility company's infeed point to the last consumer into account.

frequency inverter and radio interference suppression filters and grounding measures at the motor's site of operation. These leakage currents can exceed 3.5 mA and require increased grounding of the PDS according to EN 50178 (ground conductor cross-section $\geq 10 \text{ mm}^2$).

EMC measures

Frequency inverters work with fast electronic switches (IGBT) in the inverter. This can cause radio interference in a PDS, which, in turn, can adversely affect nearby electronic equipment. To provide protection from this high-frequency interference, these should be spatially separated and shielded from frequency-controlled PDS.

In Europe, adherence to the EMC Directive is mandatory. The EMC product standard for power drive systems (PDS) is IEC/EN 61800-3. This standard covers the complete drive system, from mains infeed to the motor.

Both versions of the frequency inverters of the M-Max™ and H-Max™ series (with built-in and external radio interference suppression filter) fulfill the requirements of the EMC product standard for residential areas (first environment), and therefore also for the higher limit values in industrial areas (second environment).

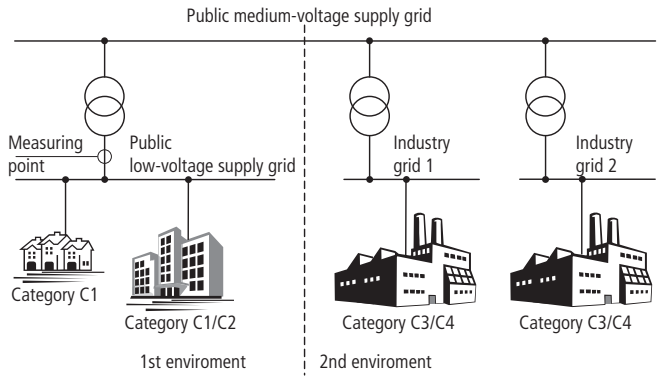

Frequency inverters

The frequency inverter is an electronic apparatus for controlling variable-speed drives with three-phase motors. It is intended for installation in a machine or for assembly with other components to a machine or plant. The main components of a modern compact frequency inverter are a power section and a control section. Example: M-Max™ series. The frequency inverter's control section contains a centrally controlling microprocessor, through which all variable values that occur in the frequency inverter are influenced. These values and all control functions are represented as parameters. The functional control of the frequency inverter and the output values in the power section (such as frequency, voltage and current) can be adjusted through:

- control terminals (I/O) with analog and digital (binary) inputs,
- a keypad with function keys and display,
- serial interfaces (bus) with RS485 (Modbus RTU) and optional field bus connections (CANopen, PROFIBUS-DP, etc.) and an optional PC connection.

Internal open and closed-loop control circuits monitor all variable values in the frequency inverter and automatically switch the process off if a quantity value reaches a dangerous level.

The power section of a static and compact frequency generally consists of three subgroups:

- Rectifier (A),
- Internal DC link (B),
- Inverter module (C).

The devices of the H-Max™ series contain a brake chopper as standard. Depending on their rating, some devices of the M-Max™ series also contain a brake chopper.

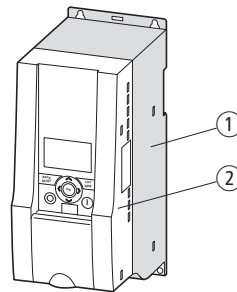

1 Power section with:

- A = Rectifier
- B = Internal DC link
- C = Inverter module

2 Control section with:

- I/O = analog and binary inputs and outputs
- KEYPAD = keypad with display
- BUS = serial interfaces (RS485, field bus, PC interface)

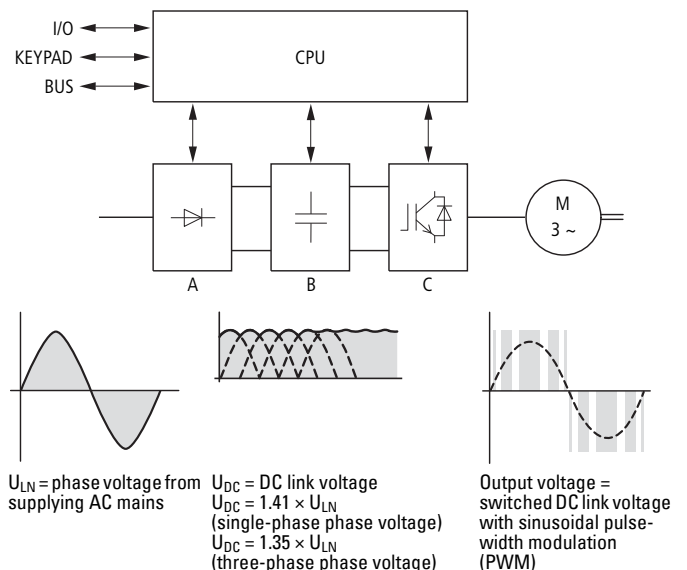

U_{LN} = phase voltage from supplying AC mains

U_{DC} = DC link voltage
 $U_{DC} = 1.41 \times U_{LN}$ (single-phase phase voltage)
 $U_{DC} = 1.35 \times U_{LN}$ (three-phase phase voltage)

Output voltage = switched DC link voltage with sinusoidal pulse-width modulation (PWM)

Block diagram with main components of a frequency inverter

Modulation

The IGBTs in the inverter of the M-Max™ and H-Max™ frequency inverters are controlled with sinusoidal pulse-width modulation (PWM). Two control methods are possible:

- Voltage/frequency (U/f) control,
- Sensorless vector control (speed control).

Voltage/frequency control is the best-known and most commonly used method. A simple characteristic curve (linear or square) defines the motor's rotating field frequency and the corresponding three-phase line-to-line voltage of the motor is selected so that the motor is neither over magnetized nor under magnetized.

The main fields of application of U/f control are:

- Pump and fan drives,
- Horizontal conveying and transportation systems,
- Drives with several motors (parallel operation of several motors at the output of a frequency inverter).

In **sensorless vector control** the magnetic fields of the stator and rotor windings are aligned so as to oppose each other. With asynchronous motors the magnetic flux in the rotor must be described in an electronic model of the motor. This requires the physical parameters on the motor's rating plate to be entered.

In vector operation the frequency inverter can control only one motor. A parallel operation of several motors is not possible here. The exact calculation of the phase voltages at the frequency inverter's output, however, improves the motor's operational behavior. The motor also heats up less in the lower speed range. The field-oriented vector control results in a significant improvement in the drive dynamics as well as optimizing performance; it also increases the range of possible applications.

The main applications of sensorless vector control are:

- Material processing machines,
- compressors,

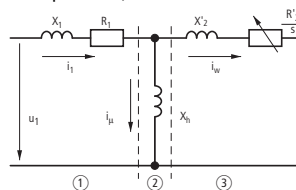

- ① Stator winding
- ② Air gap
- ③ Transformed rotor winding

Simplified equivalent circuit diagram with associated current vectors

Explanation:
 EMC = electromagnetic compatibility
 IGBT = insulated-gate bipolar transistor
 PDS = power drive system
 RCD = residual-current device

Technical information about the braking resistors:

The stated ratings P_{DB} of the braking resistors apply to continuous operation. In short-time operation these values can be increased through multiplication with the type-specific power factor according to the following formula:

$$P_{max} \leq (P_{DB} \times 100\%) \div DF [\%]$$

P_{max} = max. pulse rating

P_{DB} = continuous rating at a duty factor of 100 %

DF = duty factor

t_c = cycle time (max. 120 seconds)

The duty factor is given in percent (%) and is calculated with the following formula:

$$DF [\%] = (ED \times 100\%) \div t_c$$

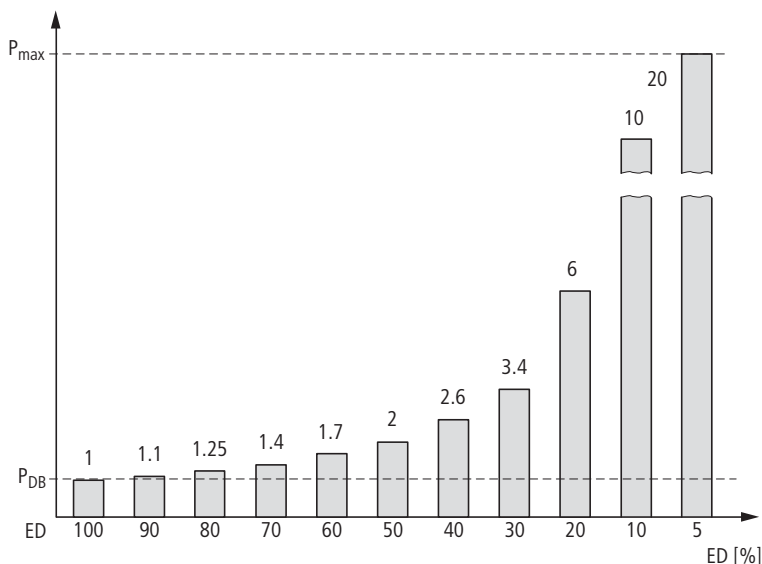
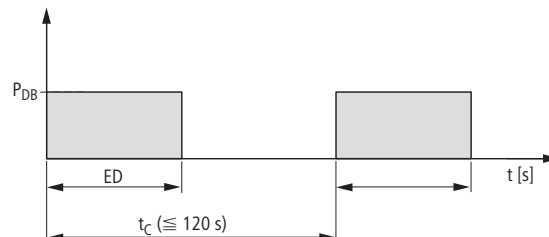

Connecting example for a 0.75 kW motor with the rating plate illustrated here

By default, the M-Max™ frequency inverters are configured so that they can be operated immediately without configuration when connected to the assigned motor rating.

To ensure an optimum operational behavior, the data on the motor's rating label should be entered in the frequency inverter (electrical image).

The following example shows the parameters for quick configuration with the selected drive-specific parameters for four standard applications.

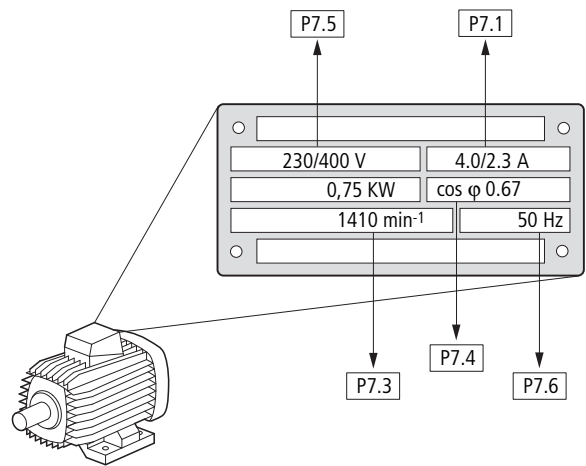

Basic (Standard drive)

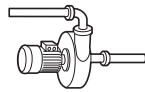

Pump drive

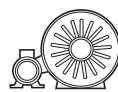

Fan drive

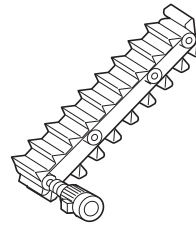

Feed unit (high load)

Parameters	Basic (Standard drive)	Pump drive	Fan drive	Feed unit (high load)	Designation
P1.1	1 = Only quick configuration parameters	1 = Only quick configuration parameters	1 = Only quick configuration parameters	1 = Only quick configuration parameters	Parameter range
P1.2	0 = Basic	1 = Pump drive	2 = Fan drive	3 = Feed unit (High load)	Application
P 1.3	0 = EU	0 = EU	0 = EU	0 = EU	Default settings country-specific (EU/USA)
P6.1	1 = Control signal terminals (I/O) (Input/Output)	1 = Control signal terminals (I/O) (Input/Output)	1 = Control signal terminals (I/O) (Input/Output)	1 = Control signal terminals (I/O) (Input/Output)	Control level
P6.2	3 = AI1 (analog setpoint value 1)	3 = AI1 (analog setpoint value 1)	3 = AI1 (analog setpoint value 1)	3 = AI1 (analog setpoint value 1)	Setpoint input (0 - 10 V) terminal 2
P6.3	0.00 Hz	20.00 Hz	20.00 Hz	0.00 Hz	Minimum frequency
P6.4	50.00 Hz	50.00 Hz	50.00 Hz	50.00 Hz	Maximum frequency
P6.5	3.0 s	5.0 s	20.0 s	1.0 s	Acceleration time (acc1)
P6.6	3.0 s	5.0 s	20.0 s	1.0 s	Deceleration time (dec1)
P 6.7	0 = Ramp (Acceleration)	0 = Ramp (Acceleration)	0 = Ramp (Acceleration)	0 = Ramp (Acceleration)	Start function
P6.8	0 = Free coasting	1 = Ramp (deceleration)	0 = Free coasting	0 = Free coasting	Stop function
P7.1	I_e	I_e	I_e	I_e	Motor, rated operational current ²⁾
P7.3	1440 rpm	1440 rpm	1440 rpm	1440 rpm	Motor, rated speed (rpm) ²⁾
P7.4	0.85	0.85	0.85	0.85	Power factor of the motor ($\cos \phi$) ²⁾
P7.5	230/400 V ¹⁾	230/400 V ¹⁾	230/400 V ¹⁾	230/400 V ¹⁾	Motor, rated operational voltage
P7.6	50.00 Hz	50.00 Hz	50.00 Hz	50.00 Hz	Motor, rated frequency
P11.7	0 = Deactivated	0 = Deactivated	0 = Deactivated	1 = Enabled	Torque increase
M1.1	0.00 Hz	0.00 Hz	0.00 Hz	0.00 Hz	Output frequency

Notes

¹⁾ 230 V = MMX12...; MMX32...; 400 V = MMX34...

²⁾ Depending on output

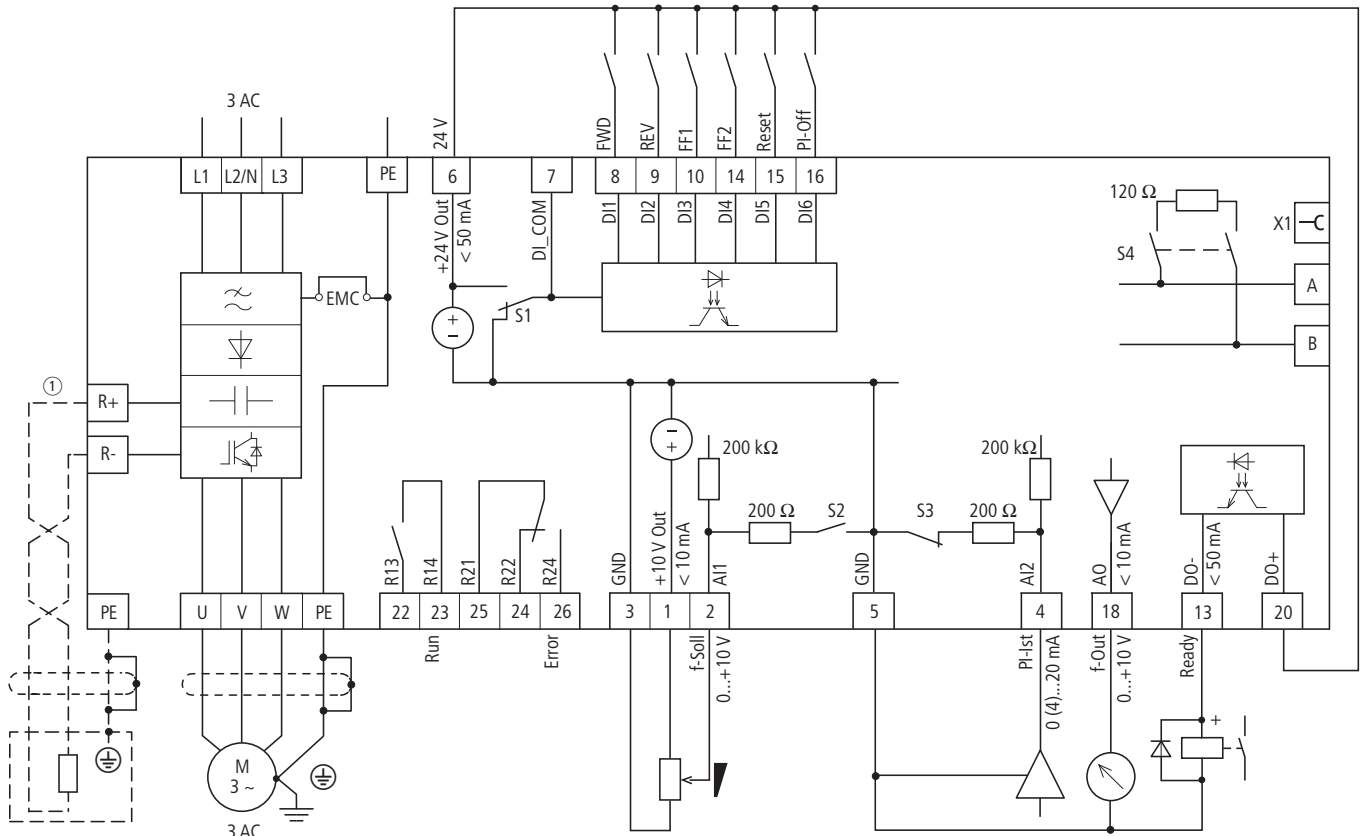

Block diagram MMX32 and MMX34

Terminals R+ and R- for external braking resistor (optional), only with MMX34...4D3..., MMX34...5D6..., MMX34...7D6..., MMX34...9D0, MMX34...012... and MMX34...014...

The control signal terminals have the following default assignment

- | | |
|--|--|
| 2: AI1: f-Soll = frequency reference value (0 - +10 V) | 13: DO-: Ready = Ready for operation (transistor output with voltage of terminal 20) |
| 4: AI2: PI-Ist = PID controller actual value (Process variable, 4 - 20 mA) | 14: DI4: FF2 = Fixed frequency 2 |
| 8: DI1: FWD = enable forward (clockwise rotating field) | 15: DI5: Reset = Error message acknowledge |
| 9: DI2: REV = enable reverse (counterclockwise rotating field) | 16: DI6: PI-Off = PID controller disabled |
| 10: DI3: FF1 = Fixed frequency 1 | 18: AO: f-Out = output frequency to motor (0 - +10 V) |
| | 20: DO+: input voltage for transistor output |
- 22/23: R13/R14: RUN = run signal (relay)
 24/25/26: R21/R22/R24: Error = error message (relay)

The function of the digital inputs and outputs, and the scaling of the analog inputs and outputs are defined with parameters. These are described in manual AWB8230-1603.

Part no.		Motor	Frequency inverters			Mains supply
With internal radio interference suppression filter	Without internal radio interference suppression filter	Assigned motor rating (U _{LN} , 50/60 Hz)	Motor current ¹⁾	Rated operational current Frequency inverters	Mains current Without mains choke	Short-circuit and cable protection (fuse) ²⁾
		P kW	I _e A	I _e A	I _{LN} A	
MMX12... frequency inverters						
Single-phase mains connection (1 AC 230 V/240 V)						
MMX12AA1D7F0-0	MMX12AA1D7N0-0	0.25	1.4	1.7	4.2	FAZ-B10/1N
MMX12AA2D4F0-0	MMX12AA2D4N0-0	0.37	2	2.4	5.7	FAZ-B10/1N
MMX12AA2D8F0-0	MMX12AA2D8N0-0	0.55	2.7	2.8	6.6	FAZ-B10/1N
MMX12AA3D7F0-0	MMX12AA3D7N0-0	0.75	3.2	3.7	8.3	FAZ-B10/1N
MMX12AA4D8F0-0	MMX12AA4D8N0-0	1.1	4.6	4.8	11.2	FAZ-B20/1N
MMX12AA7D0F0-0	MMX12AA7D0N0-0	1.5	6.3	7	14.1	FAZ-B20/1N
MMX12AA9D6F0-0	MMX12AA9D6N0-0	2.2	8.7	9.6	15.8	FAZ-B32/1N
MMX32... frequency inverters						
Three-phase mains connection (3 AC 230 V/240 V)						
MMX32AA1D7F0-0	MMX32AA1D7N0-0	0.25	1.4	1.7	2.7	FAZ-B6/3
MMX32AA2D4F0-0	MMX32AA2D4N0-0	0.37	2	2.4	3.5	FAZ-B6/3
MMX32AA2D8F0-0	MMX32AA2D8N0-0	0.55	2.7	2.8	3.8	FAZ-B6/3
MMX32AA3D7F0-0	MMX32AA3D7N0-0	0.75	3.2	3.7	4.3	FAZ-B6/3
MMX32AA4D8F0-0	MMX32AA4D8N0-0	1.1	4.6	4.8	6.8	FAZ-B10/3
MMX32AA7D0F0-0	MMX32AA7D0N0-0	1.5	6.3	7	8.4	FAZ-B10/3
MMX32AA011F0-0	MMX32AA011N0-0	2.2	8.7	11	13.4	FAZ-B20/3
MMX34... frequency inverters						
Three-phase mains connection (3 AC 400 V/480 V)						
MMX34AA1D3F0-0	MMX34AA1D3N0-0	0.37	1.1	1.3	2.2	FAZ-B6/3
MMX34AA1D9F0-0	MMX34AA1D9N0-0	0.55	1.5	1.9	2.8	FAZ-B6/3
MMX34AA2D4F0-0	MMX34AA2D4N0-0	0.75	1.9	2.4	3.2	FAZ-B6/3
MMX34AA3D3F0-0	MMX34AA3D3N0-0	1.1	2.6	3.3	4	FAZ-B6/3
MMX34AA4D3F0-0	MMX34AA4D3N0-0	1.5	3.6	4.3	5.6	FAZ-B10/3
MMX34AA5D6F0-0	MMX34AA5D6N0-0	2.2	5	5.6	7.3	FAZ-B10/3
MMX34AA7D6F0-0	MMX34AA7D6N0-0	3	6.6	7.6	9.6	FAZ-B20/3
MMX34AA9D0F0-0	MMX34AA9D0N0-0	4	8.5	9	11.5	FAZ-B20/3
MMX34AA012F0-0	MMX34AA012N0-0	5.5	11.3	12	14.9	FAZ-B20/3
MMX34AA014F0-0	MMX34AA014N0-0	7.5 ⁴⁾	15.2 ⁴⁾	14 ⁴⁾	18.7	FAZ-B25/3

- Notes** All data apply at an ambient air temperature of up to +50 °C.
- 1) The rated motor currents apply to normal internally and surface-cooled three-phase motors with 1500 rpm at 50 Hz or 1800 rpm at 60 Hz.
 - 2) If a frequency inverter is operated without mains chokes, current peaks can occur when mains power is applied. This can cause the FAZ-B... to trip prematurely.
Remedy: fit a mains choke upstream or use an FAZ-C...
 - 3) Instead of PKM0, PKZM0 can also be used.
 - 4) Reduced rated operational data: Ambient air temperature up to +40 °C, operating frequency up to 4 kHz, mounting distance at sides (left and right) > 10 mm

cable protection FAZ, PKM, PKZM → chapter 7, 19
DIL mains contactor → chapter 5
Mains chokes DEX-LN... → Page 10/20
Radio interference suppression filters MMX-LZ... → Page 10/19
DEX-LM3... motor chokes → Page 10/21
Sinusoidal filters SFB400/... please enquire

Short-circuit and cable protection (fuse)	Mains contactor	Mains contactor with parallel connector (main current-paths) ³⁾	Mains choke	Radio interference suppression filters (only for part nos. MMX...N...)	Motor connection	
					Motor chokes	Sine-wave filters
–	DILM7	DILEM+P1DILEM	DEX-LN1-006	MMX-LZ1-009	DEX-LM3-005	SFB400/4
–	DILM7	DILEM+P1DILEM	DEX-LN1-006	MMX-LZ1-009	DEX-LM3-005	SFB400/4
–	DILM7	DILEM+P1DILEM	DEX-LN1-009	MMX-LZ1-009	DEX-LM3-005	SFB400/4
–	DILM7	DILEM+P1DILEM	DEX-LN1-009	MMX-LZ1-009	DEX-LM3-005	SFB400/4
–	DILM7	–	DEX-LN1-013	MMX-LZ1-015	DEX-LM3-005	SFB400/10
–	DILM7	–	DEX-LN1-018	MMX-LZ1-015	DEX-LM3-008	SFB400/10
–	DILM7	–	DEX-LN1-018	MMX-LZ1-017	DEX-LM3-011	SFB400/10
PKM0-6,3	DILEM	–	DEX-LN3-004	MMX-LZ3-006	DEX-LM3-005	SFB400/4
PKM0-6,3	DILEM	–	DEX-LN3-004	MMX-LZ3-006	DEX-LM3-005	SFB400/4
PKM0-6,3	DILEM	–	DEX-LN3-004	MMX-LZ3-006	DEX-LM3-005	SFB400/4
PKM0-6,3	DILEM	–	DEX-LN3-006	MMX-LZ3-006	DEX-LM3-005	SFB400/4
PKM0-10	DILEM	–	DEX-LN3-010	MMX-LZ3-009	DEX-LM3-005	SFB400/10
PKM0-10	DILEM	–	DEX-LN3-010	MMX-LZ3-009	DEX-LM3-008	SFB400/10
PKM0-20	DILM7	–	DEX-LN3-016	MMX-LZ3-020	DEX-LM3-011	SFB400/10
PKM0-6,3	DILEM	–	DEX-LN3-004	MMX-LZ3-006	DEX-LM3-005	SFB400/4
PKM0-6,3	DILEM	–	DEX-LN3-004	MMX-LZ3-006	DEX-LM3-005	SFB400/4
PKM0-6,3	DILEM	–	DEX-LN3-004	MMX-LZ3-006	DEX-LM3-005	SFB400/4
PKM0-6,3	DILEM	–	DEX-LN3-006	MMX-LZ3-006	DEX-LM3-005	SFB400/4
PKM0-10	DILEM	–	DEX-LN3-006	MMX-LZ3-009	DEX-LM3-005	SFB400/4
PKM0-10	DILEM	–	DEX-LN3-010	MMX-LZ3-009	DEX-LM3-008	SFB400/10
PKM0-20	DILEM	–	DEX-LN3-010	MMX-LZ3-020	DEX-LM3-008	SFB400/10
PKM0-20	DILM7	–	DEX-LN3-016	MMX-LZ3-020	DEX-LM3-011	SFB400/10
PKM0-20	DILM7	–	DEX-LN3-016	MMX-LZ3-020	DEX-LM3-016	SFB400/16.5
PKM0-25	DILM7	–	DEX-LN3-016	MMX-LZ3-020	DEX-LM3-016	SFB400/16.5

Engineering

Part no.		Motor		Frequency inverters	
Protection type IP21	Protection type IP54	Assigned motor rating (U _{LN} , 50/60 Hz)	Motor current ¹⁾	Rated operational current Frequency inverters	Mains current (DC link choke)
		P kW	I _e A	I _e A	I _{LN} A
HMX32... frequency inverters					
Three-phase mains connection (3 AC 230 V/240 V)					
HMX32AG3D721-B	HMX32AG3D722-B	0.75	3.2	3.7	
HMX32AG4D821-B	HMX32AG4D822-B	1.1	4.6	4.8	
HMX32AG6D621-B	HMX32AG6D622-B	1.5	6.3	6.6	
HMX32AG8D021-B	HMX32AG8D022-B	1.5	6.3	8	
HMX32AG01121-B	HMX32AG01122-B	2.2	8.7	11	
HMX32AG01221-B	HMX32AG01222-B	3	11.5	12.5	
HMX32AG01821-B	HMX32AG01822-B	4	14.8	18	
HMX32AG02421-B	HMX32AG02422-B	5.5	19.6	24.2	
HMX32AG03121-B	HMX32AG03122-B	7.5	26.4	31	
HMX32AG04821-B	HMX32AG04822-B	11	38	48	
HMX32AG06221-B	HMX32AG06222-B	15	51	62	
HMX32AG07721-B	HMX32AG07722-B	18.5	63	77	
HMX32AG08821-B	HMX32AG08822-B	22	71	88	
HMX32AG10621-B	HMX32AG10622-B	30	96	106	
HMX32AG14321-B	HMX32AG14322-B	37	117	143	
HMX32AG17021-B	HMX32AG17022-B	45	141	170	
HMX32AG20521-B	HMX32AG20522-B	55	173	208	
HMX32AG26121-B	HMX32AG26122-B	75	233	261	
HMX32AG31021-B	HMX32AG31022-B	90	279	310	
HMX34... frequency inverters					
Three-phase mains connection (3 AC 400 V/480 V)					
HMX34AG3D421-B	HMX34AG3D422-B	1.1	2.6	3.4	
HMX34AG4D821-B	HMX34AG4D822-B	1.5	3.6	4.8	
HMX34AG5D621-B	HMX34AG5D622-B	2.2	5	5.6	
HMX34AG8D021-B	HMX34AG8D022-B	3	6.6	8	
HMX34AG9D621-B	HMX34AG9D622-B	4	8.5	9.6	
HMX34AG01221-B	HMX34AG01222-B	5.5	11.3	12	
HMX34AG01621-B	HMX34AG01622-B	7.5	15.2	16	
HMX34AG02321-B	HMX34AG02322-B	11	21.7	23	
HMX34AG03121-B	HMX34AG03122-B	15	29.3	31	
HMX34AG03821-B	HMX34AG03822-B	18.5	36	38	
HMX34AG04621-B	HMX34AG04622-B	22	41	46	
HMX34AG06121-B	HMX34AG06122-B	30	55	61	
HMX34AG07221-B	HMX34AG07222-B	37	68	72	
HMX34AG08721-B	HMX34AG08722-B	45	81	87	
HMX34AG10521-B	HMX34AG10522-B	55	99	105	
HMX34AG14021-B	HMX34AG14022-B	75	134	140	
HMX34AG17021-B	HMX34AG17022-B	90	161	170	
HMX34AG20521-B	HMX34AG20522-B	110	196	205	
HMX34AG26121-B	HMX34AG26122-B	132	231	261	
HMX34AG31021-B	HMX34AG31022-B	160	279	310	

Notes All data apply at an ambient air temperature of up to +40 °C.
 1) The rated motor currents apply to normal internally and surface-cooled three-phase motors with 1500 rpm at 50 Hz or 1800 rpm at 60 Hz.
 2) At motor currents above 100 A use frame size DEX-LM3-150.

DIL mains contactor → chapter 5
 DEX-LM3-... motor chokes → Page 10/21
 SFB400/... sine-wave filters please enquire

Mains supply		Motor connection	
Short-circuit and line protection (fuse) ²⁾	Mains contactor	Motor chokes	Sine-wave filters
PKM0-6,3	DILEM	DEX-LM3-005	SFB400/4
PKM0-6,3	DILEM	DEX-LM3-005	SFB400/4
PKM0-10	DILEM	DEX-LM3-008	SFB400/10
PKM0-10	DILEM	DEX-LM3-008	SFB400/10
PKM0-16	DILM7	DEX-LM3-011	SFB400/16.5
PKM0-16	DILM7	DEX-LM3-016	SFB400/16.5
PKM0-25	DILM7	DEX-LM3-035	SFB400/32
PKM0-32	DILM17	DEX-LM3-035	SFB400/32
PKM4-40	DILM17	DEX-LM3-035	SFB400/32
PKM4-50	DILM40	DEX-LM3-050	SFB400/48
PKM4-63	DILM50	DEX-LM3-063	SFB400/115
NZM...1-A80	DILM65	DEX-LM3-080	SFB400/115
NZM...1-A100	DILM80	DEX-LM3-100	SFB400/115
NZM...1-A125	DILM95	DEX-LM3-100 ²⁾	SFB400/115
NZM...1-A160	DILM150	DEX-LM3-150	SFB400/150
NZM...2-A200	DILM170	DEX-LM3-180	SFB400/180
NZM...2-A250	DILM185	DEX-LM3-220	SFB400/250
NZM...3-AE400	DILM185	DEX-LM3-260	SFB400/440
NZM...3-AE400	DILM250	Please enquire	SFB400/440
PKM0-6,3	DILEM	DEX-LM3-005	SFB400/4
PKM0-6,3	DILEM	DEX-LM3-005	SFB400/4
PKM0-6,3	DILEM	DEX-LM3-008	SFB400/10
PKM0-10	DILEM	DEX-LM3-008	SFB400/10
PKM0-10	DILEM	DEX-LM3-011	SFB400/10
PKM0-16	DILM7	DEX-LM3-016	SFB400/16.5
PKM0-16	DILM7	DEX-LM3-016	SFB400/16.5
PKM0-25	DILM7	DEX-LM3-035	SFB400/23.5
PKM0-32	DILM17	DEX-LM3-035	SFB400/32
PKM4-40	DILM17	DEX-LM3-050	SFB400/37
PKM4-50	DILM40	DEX-LM3-050	SFB400/48
PKM4-63	DILM50	DEX-LM3-063	SFB400/115
NZM...1-A80	DILM65	DEX-LM3-080	SFB400/115
NZM...1-A100	DILM80	DEX-LM3-100	SFB400/115
NZM...1-A125	DILM95	DEX-LM3-100 ²⁾	SFB400/115
NZM...1-A160	DILM150	DEX-LM3-150	SFB400/150
NZM...2-A200	DILM170	DEX-LM3-180	SFB400/180
NZM...2-A250	DILM185	DEX-LM3-220	SFB400/250
NZM...3-AE400	DILM185	DEX-LM3-260	SFB400/440
NZM...3-AE400	DILM250	Please enquire	SFB400/440

Technical data

MMX12...

			MMX...1D7...	MMX...2D4...
Power side (primary side)				
Number of phases			1 (L and N) or 2 (e.g. L1 and L2)	1 (L and N) or 2 (e.g. L1 and L2)
Mains connection voltage	U _{LN}			
IEC (50/60Hz)	V		208 -15 % - 240 +10 %	208 -15 % - 240 +10 %
UL/CSA (45 - 66 Hz ±0 %)	V		177 - 264 ±0 %	177 - 264 ±0 %
Rated operational voltage	U _e	V	230	230
Rated operational current	I _e	A	1.7	2.4
Input current	I _{LN}	A	4.2	5.7
Overload current for 60 s every 600 s at 50 °C		A	2.6	3.6
Starting current for 2 s every 20 s at 50 °C		A	3.4	4.8
Maximum leakage current to ground (PE) without motor	I _{PE}	mA	15.4	15.4
Apparent power at rated operation 230 V		kVA	0.68	0.96
Apparent power at rated operation 240 V		kVA	0.71	0.99
Assigned motor rating (230 V)	P	kWh	0.25	0.37
Assigned motor rating (230 V)	P	HP	1/3 ¹⁾	1/2
Braking torque				
Standard			Max. 30 % M _N	Max. 30 % M _N
DC braking			Max. 100 % of rated operational current I _e , adjustable	
Pulse frequency	f _{PWM}	kHz	6 (adjustable 1 – 16)	6 (adjustable 1 – 16)
Heat dissipation at rated operational current I _e	P _V	W	17.9	24.6
Efficiency	η		0.93	0.93
Fan (built into device, temperature-controlled)			•	•
Frame size			FS1	FS1
Weight	m	kg	0.55	0.55

Notes ¹⁾ Not a standardized output

MMX32...

			MMX...1D7...	MMX...2D4...
Power side (primary side):				
Number of phases			3 (L1, L2, L3)	3 (L1, L2, L3)
Mains connection voltage	U _{LN}	U _{LN}		
IEC (50/60Hz)			208 -15 % - 240 +10 %	208 -15 % - 240 +10 %
UL/CSA (45 - 66 Hz ±0 %)			177 - 264 ±0 %	177 - 264 ±0 %
Rated operational voltage	U _e	U _e	230	230
Rated operational current	I _e	I _e	1.7	2.4
Input current	I _{LN}	I _{LN}	2.7	3.5
Overload current for 60 s every 600 s at 50 °C			2.6	3.6
Starting current for 2 s every 20 s at 50 °C			3.4	4.8
Maximum leakage current to ground (PE) without motor		I _{PE}	8.6	8.6
Apparent power at rated operation 230 V			0.68	0.96
Apparent power at rated operation 240 V			0.71	0.99
Assigned motor rating (230 V)		P	0.25	0.37
Assigned motor rating (230 V)		P	1/3 ¹⁾	1/2
Braking torque				
Standard			Max. 30 % M _N	Max. 30 % M _N
DC braking			Max. 100 % of rated operational current I _e , adjustable	
Pulse frequency		f _{PWM}	6 (adjustable 1 – 16)	6 (adjustable 1 – 16)
Heat dissipation at rated operational current I _e		P _V	17.4	23.7
Efficiency		η	0.93	0.94
Fan (built into device, temperature-controlled)			•	•
Frame size			FS1	FS1
Weight		m	0.55	0.55

Notes ¹⁾ Guide value, not a standardized output

MMX...2D8...	MMX...3D7...	MMX...4D8...	MMX...7D0...	MMX...9D6...
1 (L and N) or 2 (e.g. L1 and L2)				
208 -15 % - 240 +10 %	208 -15 % - 240 +10 %	208 -15 % - 240 +10 %	208 -15 % - 240 +10 %	208 -15 % - 240 +10 %
177 - 264 ±0 %	177 - 264 ±0 %	177 - 264 ±0 %	177 - 264 ±0 %	177 - 264 ±0 %
230	230	230	230	230
2.8	3.7	4.8	7	9.6
6.6	8.3	11.2	14.1	15.8
4.2	5.6	7.2	10.4	14.4
5.6	7.4	9.6	14	19.2
15.4	11.8	11.8	11.8	24.4
1.12	1.47	1.91	2.79	3.82
1.16	1.54	1.99	2.91	3.99
0.55	0.75	1.1	1.5	2.2
1/2	3/4	1.0	2.0	3.0
Max. 30 % M _N				
Max. 100 % of rated operational current I _e , adjustable				
6 (adjustable 1 – 16)	6 (adjustable 1 – 16)	6 (adjustable 1 – 16)	6 (adjustable 1 – 16)	6 (adjustable 1 – 16)
29.2	40.2	49.6	66.8	78.1
0.95	0.95	0.95	0.96	0.96
•	•	•	•	•
FS1	FS2	FS2	FS2	FS3
0.55	0.70	0.70	0.70	0.99

MMX...2D8...	MMX...3D7...	MMX...4D8...	MMX...7D0...	MMX... 011...
3 (L1, L2, L3)				
208 -15 % - 240 +10 %	208 -15 % - 240 +10 %	208 -15 % - 240 +10 %	208 -15 % - 240 +10 %	208 -15 % - 240 +10 %
177 - 264 ±0 %	177 - 264 ±0 %	177 - 264 ±0 %	177 - 264 ±0 %	177 - 264 ±0 %
230	230	230	230	230
2.8	3.7	4.8	7	11
3.8	4.3	6.8	8.4	13.4
4.2	5.6	7.2	10.4	14.4
5.6	7.4	9.6	14	19.2
8.6	16.1	16.1	16.1	8.6
1.12	1.47	1.91	2.79	3.82
1.16	1.54	1.99	2.91	3.99
0.55	0.75	1.1	1.5	2.2
1/2	3/4	1.0	2.0	3.0
Max. 30 % M _N				
Max. 100 % of rated operational current I _e , adjustable				
6 (adjustable 1 – 16)	6 (adjustable 1 – 16)	6 (adjustable 1 – 16)	6 (adjustable 1 – 16)	6 (adjustable 1 – 16)
28.3	37.9	48.4	63.8	84.0
0.95	0.95	0.96	0.96	0.96
•	•	•	•	•
FS1	FS2	FS2	FS2	FS3
0.55	0.70	0.70	0.70	0.99

			MMX...1D3...	MMX...1D9...	MMX...2D4...
Power side (primary side):					
Number of phases			3 (L1, L2, L3)	3 (L1, L2, L3)	3 (L1, L2, L3)
Mains connection voltage					
IEC (50/60Hz)	U _{LN}	V	380 -15 % - 480 +10 %	380 -15 % - 480 +10 %	380 -15 % - 480 +10 %
UL/CSA (45 - 66 Hz ±0 %)		V	323 - 528 ±0 %	323 - 528 ±0 %	323 - 528 ±0 %
Rated operational voltage	U _e	V	400	400	400
Rated operational current	I _e	A	1.3	1.9	2.4
Input current	I _{LN}	A	2.2	2.8	3.2
Overload current for 60 s every 600 s at 50 °C		A	2.0	2.9	3.6
Starting current for 2 s every 20 s at 50 °C		A	2.6	3.8	4.8
Maximum leakage current to ground (PE) without motor	I _{PE}	mA	45.1	45.1	45.1
Apparent power at rated operation 400 V		kVA	0.9	1.32	1.66
Apparent power at rated operation 480 V		kVA	1.08	1.56	2.00
Assigned motor (400 V)	P	kWh	0.37	0.55	0.75
Assigned motor rating (460 V)	P	HP	1/2	3/4	1
Braking torque					
Standard			Max. 30 % M _N	Max. 30 % M _N	Max. 30 % M _N
DC braking			Max. 100 % of rated operational current I _e , adjustable	Max. 100 % of rated operational current I _e , adjustable	Max. 100 % of rated operational current I _e , adjustable
Brake chopper with external braking resistor					
Minimum braking resistance	R _B	Ω			
Closing ripple for braking transistor	U _{DC}	V DC			
Pulse frequency	f _{PWM}	kHz	6 (adjustable 1 – 16)	6 (adjustable 1 – 16)	6 (adjustable 1 – 16)
Heat dissipation at rated operational current I _e	P _V	W	21.7	29.7	31.7
Efficiency	η		0.94	0.95	0.95
Fan (built into device, temperature-controlled)			•	•	•
Frame size			FS1	FS1	FS1
Weight	m	kg	0.55	0.55	0.55

Notes
¹⁾ The rated operational data of the MMX34AA014... is limited to 4 kHz at a maximum ambient air temperature of +40 °C.
²⁾ Assigned motor rating with reduced load torque (about -10 %)
³⁾ Guide value, not a standardized output

MMX...3D3...	MMX...4D3...	MMX...5D6...	MMX...7D6...	MMX...9D0...	MMX...012...	MMX...014...
3 (L1, L2, L3)	3 (L1, L2, L3)	3 (L1, L2, L3)	3 (L1, L2, L3)	3 (L1, L2, L3)	3 (L1, L2, L3)	3 (L1, L2, L3)
380 -15 % - 480 +10 %	380 -15 % - 480 +10 %	380 -15 % - 480 +10 %	380 -15 % - 480 +10 %	380 -15 % - 480 +10 %	380 -15 % - 480 +10 %	380 -15 % - 480 +10 %
323 - 528 ±0 %	323 - 528 ±0 %	323 - 528 ±0 %	323 - 528 ±0 %	323 - 528 ±0 %	323 - 528 ±0 %	323 - 528 ±0 %
400	400	400	400	400	400	400
3.3	4.3	5.6	7.6	9.0	12.0	21.0
4.0	5.6	7.3	9.6	11.5	14.9	18.7
5.0	6.5	8.4	11.4	13.5	18.0	21.0
6.6	8.6	11.2	15.2	18.0	24.0	28.0
25.1	25.1	25.1	24.9	24.9	24.9	24.9
2.29	2.98	3.88	5.27	6.24	8.32	9.70
2.74	3.57	4.66	6.32	7.48	9.98	11.64
1.10	1.50	2.20	3.00	4.00	5.50	7.50 ²⁾
1-1/2	2	3	4 ³⁾	5	7-1/2	10
Max. 30 % M _N	Max. 30 % M _N	Max. 30 % M _N	Max. 30 % M _N	Max. 30 % M _N	Max. 30 % M _N	Max. 30 % M _N
Max. 100 % of rated operational current I _e , adjustable	Max. 100 % of rated operational current I _e , adjustable	Max. 100 % of rated operational current I _e , adjustable	Max. 100 % of rated operational current I _e , adjustable	Max. 100 % of rated operational current I _e , adjustable	Max. 100 % of rated operational current I _e , adjustable	Max. 100 % of rated operational current I _e , adjustable
Max. 100 % of rated operational current I _e with external braking resistor	Max. 100 % of rated operational current I _e with external braking resistor	Max. 100 % of rated operational current I _e with external braking resistor	Max. 100 % of rated operational current I _e with external braking resistor	Max. 100 % of rated operational current I _e with external braking resistor	Max. 100 % of rated operational current I _e with external braking resistor	Max. 100 % of rated operational current I _e with external braking resistor
55	55	55	35	35	35	35
765	765	765	765	765	765	765
6 (adjustable 1 – 16)	6 (adjustable 1 – 16)	6 (adjustable 1 – 16)	6 (adjustable 1 – 16)	6 (adjustable 1 – 16)	6 (adjustable 1 – 16)	1 - 4, adjustable
51.5	66.4	88.3	116.9	136.2	185.1	223.7
0.95	0.96	0.96	0.96	0.97	0.97	0.97
•	•	•	•	•	•	•
FS2	FS2	FS2	FS3	FS3	FS3	FS3
0.70	0.70	0.70	0.99	0.99	0.99	0.99

Technical data

			Mains chokes DEX-LN1-...	Mains chokes DEX-LN3-...	DEX-LM3-... motor chokes
General					
Standards			IEC/EN 61558-2-20-2000, VDE 0570 Part 2-20/04-2001, UL, CSA	IEC/EN 61558-2-20-2000, VDE 0570 Part 2-20/04-2001, UL, CSA	IEC/EN 61558-2-20-2000, VDE 0570 Part 2-20/04-2001, UL, CSA
Operating temperature	θ	°C	-25 – +40, up to 70 with current reduction (see note)	-25 – +40, up to 70 with current reduction (see note)	-25 – +40, up to 70 with current reduction (see note)
Storage temperature	θ	°C	-25 - +85	-25 - +85	-25 - +85
Mechanical shock resistance			11 ms ² /15 g, 3 impacts	11 ms ² /15 g, 3 impacts	11 ms ² /15 g, 3 impacts
Resistance to vibration		g	1 (0 - 150 Hz)	1 (0 - 150 Hz)	1 (0 - 150 Hz)
Vibration			0.35 mm at 10 - 55 Hz	0.35 mm at 10 - 55 Hz	0.35 mm at 10 - 55 Hz
Pollution degree			1 (VDE 0160)	1 (VDE 0160)	1 (VDE 0160)
Installation altitude	H	m	0 – 1000 above seal level, up to 5000 with current reduction (see note)	0 – 1000 above seal level, up to 5000 with current reduction (see note)	0 – 1000 above seal level, up to 5000 with current reduction (see note)
Mounting position			Standing vertically, suspended horizontally	Standing vertically, suspended horizontally	Standing vertically, suspended horizontally
Free surrounding areas			< 50	< 50	< 50
Degree of protection (terminals)			IP20	IP20 to 40 A IP00 from 50 A	IP20 up to 50 A IP00 from 63 A
Rated duty factor		% DF	100	100	100
Overload cycle			1.5 x I _e for 60 s every 600 s	1.5 x I _e for 60 s every 600 s	1.5 x I _e for 60 s every 600 s (< 24 A) 1.2 x I _e for 60 s every 600 s (> 24 A)
Weight	m	kg	0.7 - 2	1.5 - 20.6	1.5 - 45
Electrical data					
Rated operational voltage	U _e	V AC	230/240	400/480	230/400/460/575
Max. supply voltage	U _L	V AC	260 +0 %	550 +0 %	750 +0 %
Operating frequency	f	Hz	50/60	50/60	0 - 200
Insulation class			B	B	B (100 A) F (150 A)
Electrical connection					
Terminations			●	● (≤ 40 A)	● (≤ 40 A)
Connection lugs			–	● (≥ 50 A)	● (≥ 63 A)
PE stud			●	●	●

Notes

All rated operational data is based on an ambient air temperature of +40 °C. An ambient air temperature of +50 °C results in a derating of 4 percent.

The derating due to altitude relates to the rated operational current, I_e.

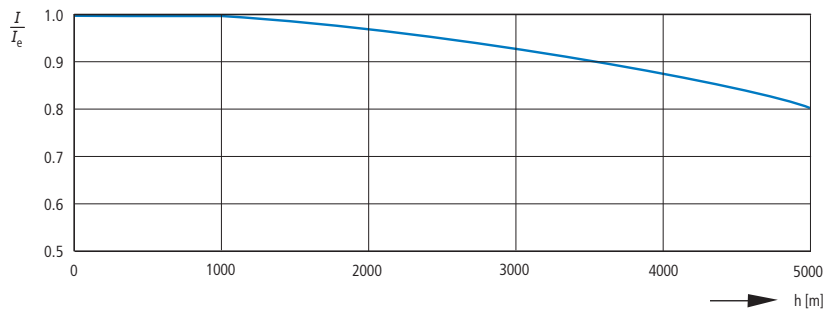

DEX-LN..., DEX-LM3...

Part no.	Rated operating current	Inductance L mH	Maximum heat dissipation P _v W	Cu factor ¹⁾	Voltage drop u _k %	Connection Terminal/connection lug		Bore hole mm	Pick-up Nm
	I _e A					mm ²	AWG		

Mains chokes, single-phase, rated operational voltage 1 AC 230 V, 50 Hz

DEX-LN1-006	5.8	5.05	9	0.09	4	4	20 - 10	–	0.8
DEX-LN1-009	8.6	3.41	11	0.11	4	4	20 - 10	–	0.8
DEX-LN1-013	13	2.25	12	0.18	4	4	20 - 10	–	0.8
DEX-LN1-018	18	1.63	17	0.27	4	4	20 - 10	–	0.8
DEX-LN1-024	24	1.22	20	0.33	4	4	20 - 10	–	0.8

Mains chokes, three-phase, rated operational voltage 3 AC 400 V, 50 Hz

DEX-LN3-004	3.9	7.51	17	0.25	4	4	20 - 10	–	0.8
DEX-LN3-006	6	4.9	19	0.34	4	4	20 - 10	–	0.8
DEX-LN3-010	10	2.94	33	0.45	4	4	20 - 10	–	0.8
DEX-LN3-016	16	1.84	44	0.53	4	4	20 - 10	–	0.8
DEX-LN3-025	25	1.18	57	0.90	4	4	20 - 10	–	0.8
DEX-LN3-040	40	0.64	59	0.91	2.5	10	20 - 6	–	1.5
DEX-LN3-050	50	0.37	58	1.08	2.5		Cu 15 x 2	7	3
DEX-LN3-060	60	0.31	60	1.51	2.5		Cu 15 x 2	7	3
DEX-LN3-080	80	0.23	86	1.67	2.5		Cu 20 x 3	9	6
DEX-LN3-100	100	0.18	101	1.68	2.5		Cu 20 x 3	9	6
DEX-LN3-120	120	0.15	100	2.26	2.5		Cu 25 x 5	11	10
DEX-LN3-160	160	0.11	140	2.35	2.5		Cu 25 x 5	11	10
DEX-LN3-200	200	0.09	154	3.81	2.5		Cu 25 x 5	11	10
DEX-LN3-250	250	0.07	155	4.26	0		Cu 40 x 5	14	15.5
DEX-LN3-300	300	0.06	169	4.28	2.5		Cu 40 x 5	14	15.5

Part no.	Rated operating current I _e A	Inductance L mH	Maximum heat dissipation P _v W	Max. heat dissipation (pulse frequency)			Cu factor ¹⁾	Connection Terminal/connection lug		Bore hole mm	Pick-up Nm
				P _v (3 kHz) W	P _v (5 kHz) W	P _v (12 kHz) W		mm ²	AWG		

Motor chokes, three-phase, rated operational voltage 3 AC 400 V, max. 200 Hz

DEX-LM3-005	5	2	24	12	14	24	0.29	4	20 - 10	–	0.8
DEX-LM3-008	8	4.1	54	32	46	54	1.09	4	20 - 10	–	0.8
DEX-LM3-011	11	3	71	45	66	71	1.23	4	20 - 10	–	0.8
DEX-LM3-016	16	1.5	78	50	75	78	0.88	4	20 - 10	–	0.8
DEX-LM3-035	35	1	116	75	114	116	2.30	4	20 - 10	–	0.8
DEX-LM3-050	50	0.6	168	110	157	168	3.60	10	20 - 6	–	1.5
DEX-LM3-063	63	0.5	193	130	190	193	3.01		Cu 15 x 2	7	3
DEX-LM3-080	80	0.5	206	132	206	206	5.88		Cu 20 x 3	9	6
DEX-LM3-100	100	0.45	294	177	279	294	10.10		Cu 20 x 3	9	6
DEX-LM3-150	150	0.35	424	293	418	424	8.22		Cu 25 x 5	11	10
DEX-LM3-180	180	0.3	498	418	439	498	14.75		Cu 25 x 5	11	10
DEX-LM3-220	220	0.2	517	344	512	517	11.37		Cu 40 x 5	14	15.5
DEX-LM3-260	260	0.15	520	358	526	520	11.10		Cu 40 x 5	14	15.5

Notes

¹⁾ For material price surcharge → Chapter General information



Dimensions

MMX12AA1D7...
MMX12AA2D4...
MMX12AA2D8...
MMX32AA1D7...
MMX32AA2D4...
MMX32AA2D8...
MMX34AA1D3...
MMX34AA1D9...
MMX34AA2D4...

MMX12AA3D7...
MMX12AA4D8...
MMX12AA7D0...
MMX32AA3D7...
MMX32AA4D8...
MMX32AA7D0...
MMX34AA3D3...
MMX34AA4D3...
MMX34AA5D6...

MMX12AA7D0...
MMX32AA011...
MMX34AA7D6...
MMX34AA9D0...
MMX34AA012...
MMX34AA014...

FS1

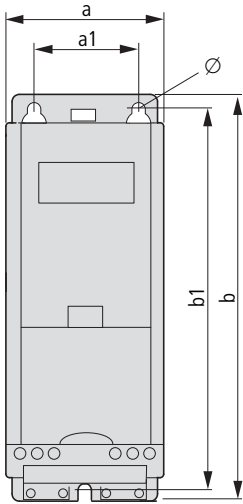

FS2

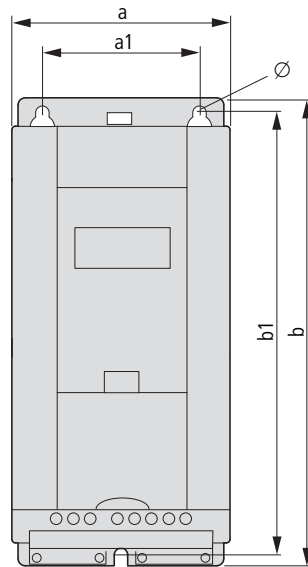

FS3

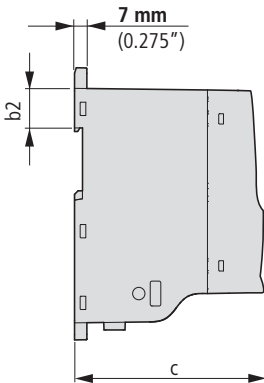
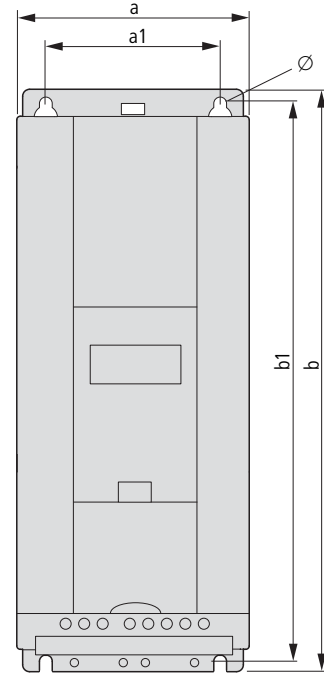

1 mm = 0.0394 inches
1 inch (1") = 25.4 mm

Part no.	a	a1	b	b1	b2	c	∅	Weight	Frame size
	mm	mm	mm	mm	mm	mm	mm	kg	
MMX12AA1D7...	66	38	160	147	32	102	4.5	0.55	FS1
MMX12AA2D4...	66	38	160	147	32	102	4.5	0.55	FS1
MMX12AA2D8...	66	38	160	147	32	102	4.5	0.55	FS1
MMX12AA3D7...	90	62.5	195	182	32	105	5.5	0.7	FS2
MMX12AA4D8...	90	62.5	195	182	32	105	5.5	0.7	FS2
MMX12AA7D0...	90	62.5	195	182	32	105	5.5	0.7	FS2
MMX12AA9D6...	100	75	253	242	34	112	5.5	0.99	FS3
MMX32AA1D7...	66	38	160	147	32	102	4.5	0.55	FS1
MMX32AA2D4...	66	38	160	147	32	102	4.5	0.55	FS1
MMX32AA2D8...	66	38	160	147	32	102	4.5	0.55	FS1
MMX32AA3D7...	90	62.5	195	182	32	105	5.5	0.7	FS2
MMX32AA4D8...	90	62.5	195	182	32	105	5.5	0.7	FS2
MMX32AA7D0...	90	62.5	195	182	32	105	5.5	0.7	FS2
MMX32AA011...	100	75	253	242	34	112	5.5	0.99	FS3
MMX34AA1D3...	66	38	160	147	32	102	4.5	0.55	FS1
MMX34AA1D9...	66	38	160	147	32	102	4.5	0.55	FS1
MMX34AA2D4...	66	38	160	147	32	102	4.5	0.55	FS1
MMX34AA3D3...	90	62.5	195	182	32	105	5.5	0.7	FS2
MMX34AA4D3...	90	62.5	195	182	32	105	5.5	0.7	FS2
MMX34AA5D6...	90	62.5	195	182	32	105	5.5	0.7	FS2
MMX34AA7D6...	100	75	253	242	34	112	5.5	0.99	FS3
MMX34AA9D0...	100	75	253	242	34	112	5.5	0.99	FS3
MMX34AA012...	100	75	253	242	34	112	5.5	0.99	FS3
MMX34AA014...	100	75	253	242	34	112	5.5	0.99	FS3

FS = frame size

Dimensions

Frequency inverters

- | | |
|----------------|----------------|
| HMX32AG3D721-B | HMX34AG3D421-B |
| HMX32AG4D821-B | HMX34AG4D821-B |
| HMX32AG6D621-B | HMX34AG5D621-B |
| HMX32AG8D021-B | HMX34AG8D021-B |
| HMX32AG01121-B | HMX34AG9D621-B |
| HMX32AG01221-B | HMX34AG01221-B |
| HMX32AG3D722-B | HMX34AG3D422-B |
| HMX32AG4D822-B | HMX34AG4D822-B |
| HMX32AG6D622-B | HMX34AG5D622-B |
| HMX32AG8D022-B | HMX34AG8D022-B |
| HMX32AG01122-B | HMX34AG9D622-B |
| HMX32AG01222-B | HMX34AG01222-B |

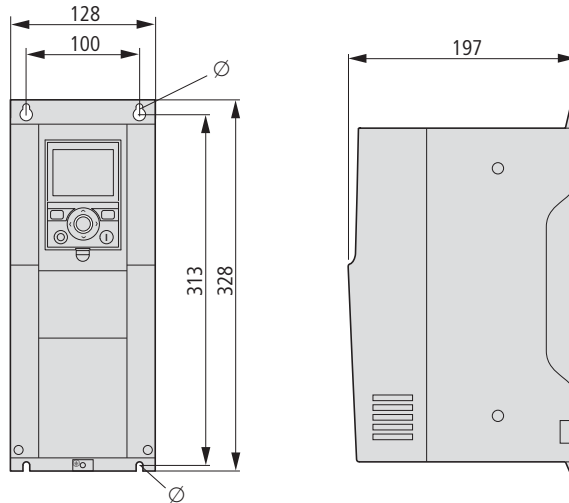

- | | |
|----------------|----------------|
| HMX32AG01821-B | HMX34AG01621-B |
| HMX32AG02421-B | HMX34AG02321-B |
| HMX32AG03121-B | HMX34AG03121-B |
| HMX32AG01822-B | HMX34AG01622-B |
| HMX32AG02422-B | HMX34AG02322-B |
| HMX32AG03122-B | HMX34AG03122-B |

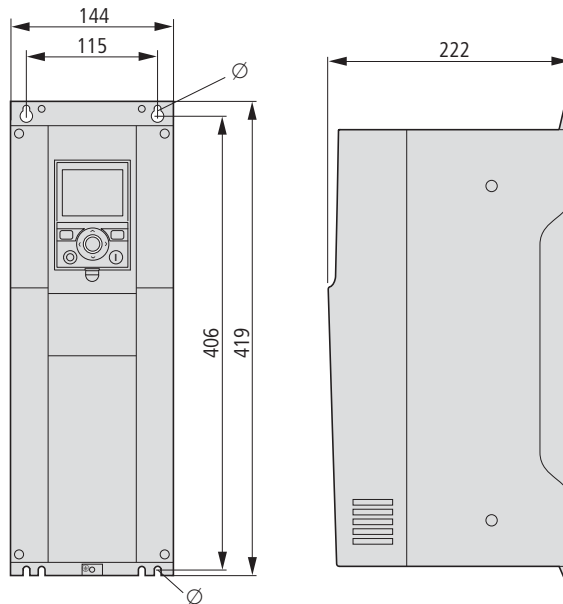

- | | |
|----------------|----------------|
| HMX32AG04821-B | HMX34AG03821-B |
| HMX32AG06221-B | HMX34AG04621-B |
| HMX32AG04822-B | HMX34AG06121-B |
| HMX32AG06222-B | HMX34AG03822-B |
| | HMX34AG04622-B |
| | HMX34AG06122-B |

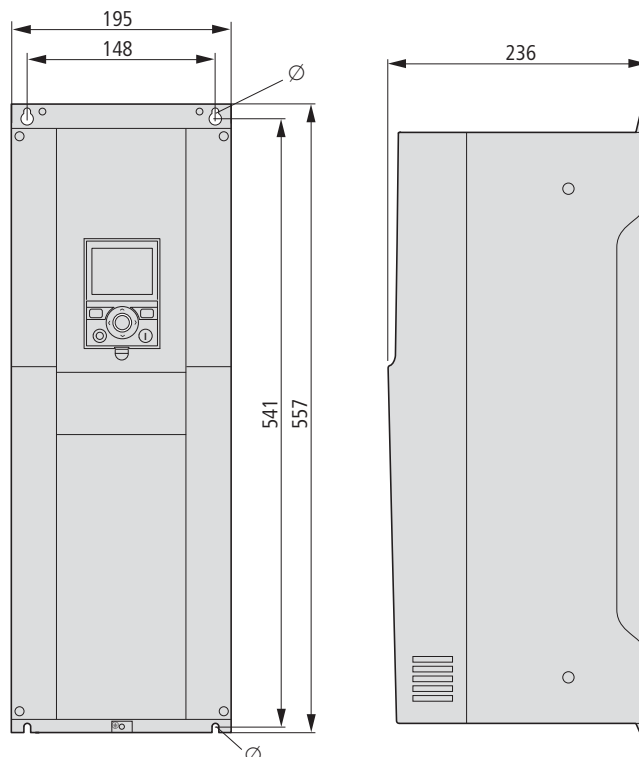

10/40 Frequency inverters

HMX...

Part no.	a mm	a1 mm	b mm	b1 mm	c mm	Ø mm	Weight kg	Frame size FS
HMX32AG011...	128	100	328	313	197	7	6	FS4
HMX32AG012...	128	100	328	313	197	7	6	FS4
HMX32AG018...	144	115	419	406	222	7	10	FS5
HMX32AG024...	144	115	419	406	222	7	10	FS5
HMX32AG031...	144	115	419	406	222	7	10	FS5
HMX32AG048...	195	148	557	541	236	9	20	FS6
HMX32AG062...	195	148	557	541	236	9	20	FS6
HMX32AG077...	234		660		266		37.5	FS7
HMX32AG088...	234		660		266		37.5	FS7
HMX32AG106...	234		660		266		37.5	FS7
HMX32AG143...	290		966		350		70	FS8
HMX32AG170...	290		966		350		70	FS8
HMX32AG208...	290		966		350		70	FS8
HMX32AG261...	480		1150		372		108	FS9
HMX32AG310...	480		1150		372		108	FS9
HMX32AG3D7...	128	100	328	313	197	7	6	FS4
HMX32AG4D8...	128	100	328	313	197	7	6	FS4
HMX32AG6D6...	128	100	328	313	197	7	6	FS4
HMX32AG8D0...	128	100	328	313	197	7	6	FS4
HMX34AG012...	128	100	328	313	197	7	6	FS4
HMX34AG016...	144	115	419	406	222	7	10	FS5
HMX34AG023...	144	115	419	406	222	7	10	FS5
HMX34AG031...	144	115	419	406	222	7	10	FS5
HMX34AG038...	195	148	557	541	236	9	20	FS6
HMX34AG046...	195	148	557	541	236	9	20	FS6
HMX34AG061...	195	148	557	541	236	9	20	FS6
HMX34AG077...	234		660		266		37.5	FS7
HMX34AG088...	234		660		266		37.5	FS7
HMX34AG106...	234		660		266		37.5	FS7
HMX34AG140...	290		966		350		70	FS8
HMX34AG170...	290		966		350		70	FS8
HMX34AG205...	290		966		350		70	FS8
HMX34AG261...	480		1150		372		108	FS9
HMX34AG310...	480		1150		372		108	FS9
HMX34AG3D4...	128	100	328	313	197	7	6	FS4
HMX34AG4D8...	128	100	328	313	197	7	6	FS4
HMX34AG5D6...	128	100	328	313	197	7	6	FS4
HMX34AG8D0...	128	100	328	313	197	7	6	FS4
HMX34AG9D6...	128	100	328	313	197	7	6	FS4

FS = frame size

BR2...-T-SAF, BR1...-T-PF, BR3...-T-PF; MMX-COM-PC

Braking resistors

- BR2036400-T-SAF
- BR2047240-T-SAF
- BR2060200-T-SAF
- BR2065400-T-SAF
- BR2075480-T-SAF

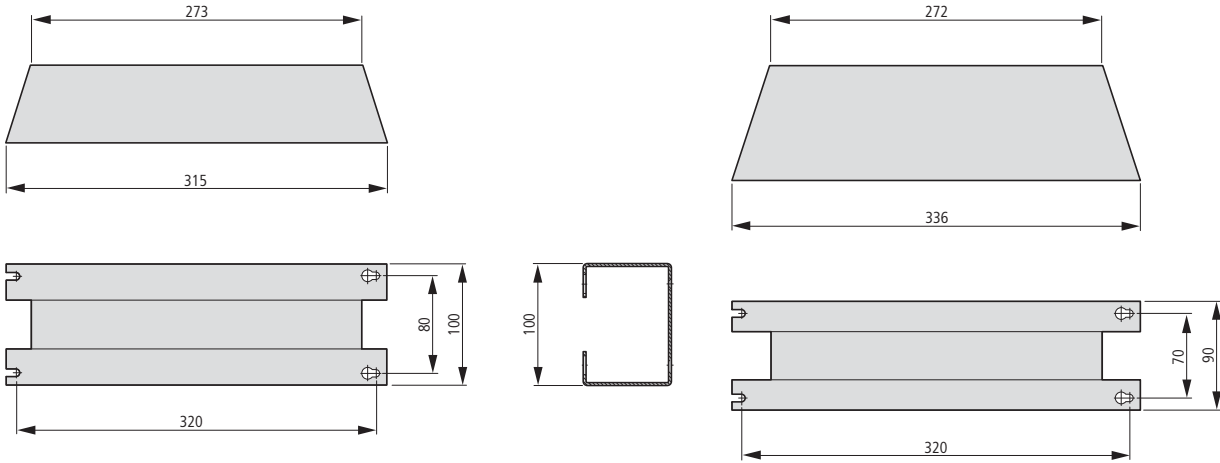

Braking resistors

- BR10361K0-T-PF
- BR10561K0-T-PF
- BR1036500-T-PF
- BR1056300-T-PF
- BR1056800-T-PF
- BR30362K4-T-PF
- BR30362K8-T-PF
- BR30363K6-T-PF

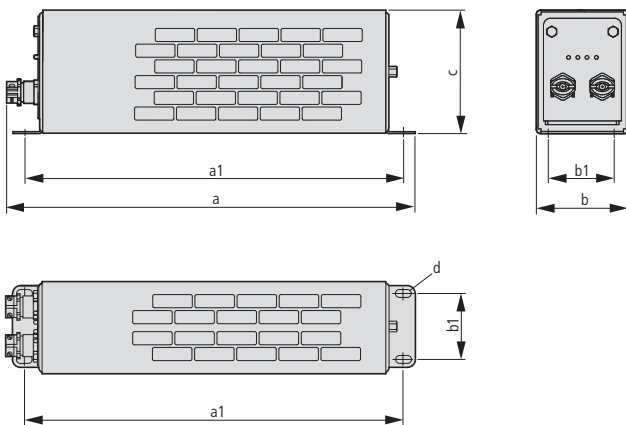

Part no.	a mm	a1 mm	b mm	b1 mm	c mm	d mm
BR10361K0-T-PF	445	428	140	120	120	6 x 12
BR10561K0-T-PF	445	428	140	120	120	6 x 12
BR1036500-T-PF	445	428	95	70	95	6 x 12
BR1056300-T-PF	335	328	95	70	95	6 x 12
BR1056800-T-PF	395	378	140	120	120	6 x 12
BR30362K4-T-PF	485	380	326	300	301	9
BR30362K8-T-PF	485	380	326	300	301	9
BR30363K6-T-PF	485	380	326	300	301	9

PC interfacing

MMX-COM-PC

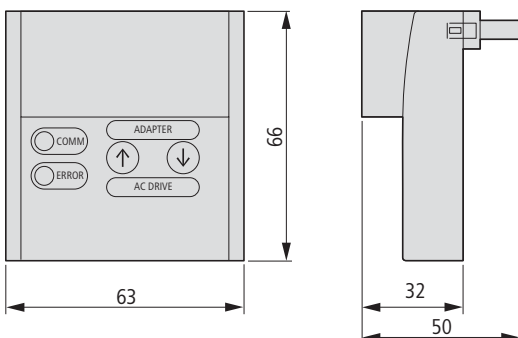

MMX-LZ1-009

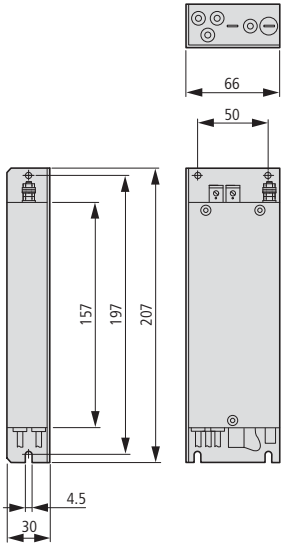

MMX-LZ1-015

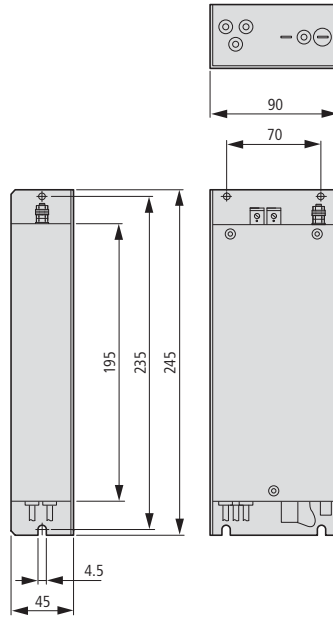

MMX-LZ1-017

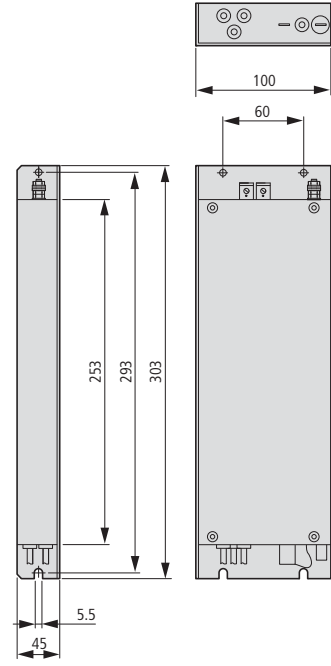

MMX-LZ3-006

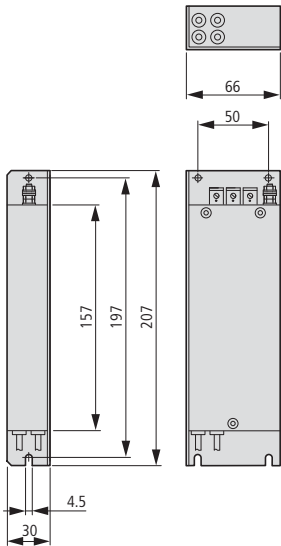

MMX-LZ3-009

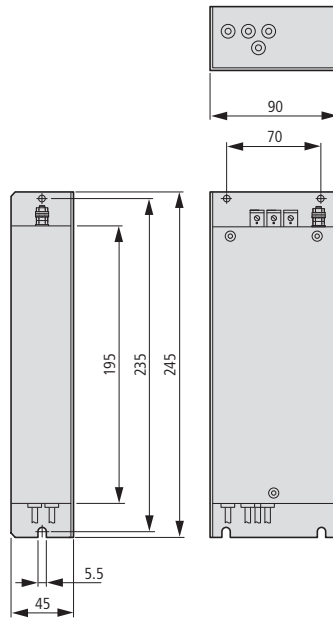

MMX-LZ3-020

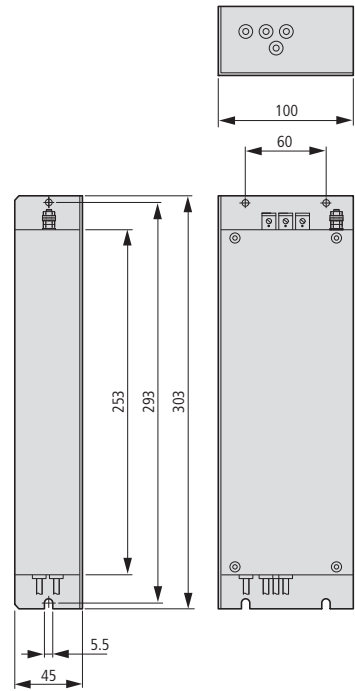

Mains chokes

DEX-LN1-...

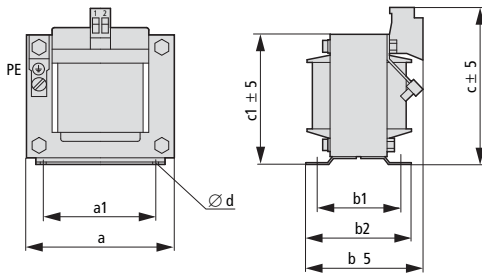

Part no.	a mm	a1 mm	b mm	b1 mm	b2 mm	c mm	c1 mm	Ød mm	Weight kg
DEX-LN1-006	66	50	71	44	55	80	61	4.5 x 8	0.7
DEX-LN1-009	66	50	71	44	55	80	61	4.5 x 8	0.7
DEX-LN1-013	84	64	67	47	60	90	75	4.8 x 8	1.5
DEX-LN1-018	84	64	90	70	83	90	75	4.8 x 8	1.5
DEX-LN1-024	84	64	67	47	60	90	75	4.8 x 8	2

Mains chokes/motor chokes

DEX-LN3-..., DEX-LM3-...

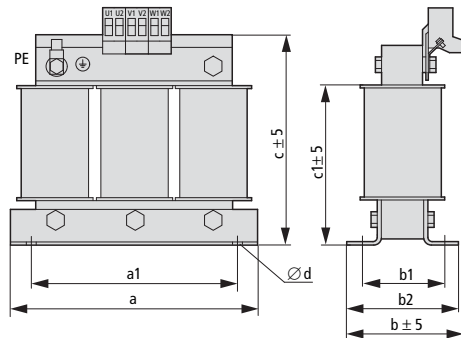

Part no.	a mm	a1 mm	b mm	b1 mm	b2 mm	c mm	c1 mm	Ød mm	Weight kg
DEX-LN3-004	115	100	66	50	66	118	84	5 x 10	1.5
DEX-LN3-006	115	100	66	50	66	118	84	5 x 10	1.5
DEX-LN3-010	140	125	61	50	61	138	105	5 x 10	2.2
DEX-LN3-016	140	125	71	50	71	138	105	5 x 10	2.9
DEX-LN3-025	195	175	104	50	76.5	175	134	8 x 13	4.8
DEX-LN3-040	195	175	104	50	76.5	188	134	8 x 13	4.8
DEX-LM3-005	115	100	66	50	66	118	84	5 x 10	1.5
DEX-LM3-008	195	175	104	50	76.5	175	134	8 x 13	4.8
DEX-LM3-011	195	175	104	50	76.5	175	134	8 x 13	4.8
DEX-LM3-016	195	175	104	50	76.5	175	134	8 x 13	4.8
DEX-LM3-035	220	200	132	75	101.5	195	160	8 x 13	7.3
DEX-LM3-050	270	250	106	75	96	228	198	8 x 13	12.3

Mains chokes/motor chokes

DEX-LN3-..., DEX-LM3-...

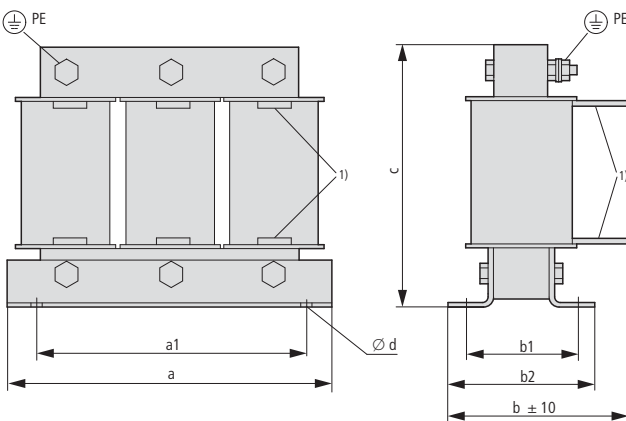

Part no.	a mm	a1 mm	b mm	b1 mm	b2 mm	c ²⁾ mm	Ød mm	Weight kg
DEX-LN3-050	195	175	105	75	91.5	132 ± 5	8 x 13	5.9
DEX-LN3-060	195	175	105	75	91.5	132 ± 5	8 x 13	5.9
DEX-LN3-080	220	200	110	50	81.5	160 ± 5	8 x 13	7.3
DEX-LN3-100	220	200	130	75	101.5	160 ± 5	8 x 13	10.2
DEX-LN3-120	220	200	130	75	101.5	160 ± 5	8 x 13	10.2
DEX-LN3-160	270	250	125	75	96	200 ± 5	8 x 13	12.3
DEX-LN3-200	270	250	155	100	120	202 ± 5	8 x 13	14.9
DEX-LN3-250	270	250	155	100	125	210 ± 5	10 x 18	20.6
DEX-LN3-300	270	250	155	100	125	210 ± 5	10 x 18	20.6
DEX-LM3-063	270	250	155	100	120	202 ± 10	8 x 13	14.9
DEX-LM3-080	270	250	155	100	125	210 ± 10	10 x 18	20.6
DEX-LM3-100	384	350	215	100	130	258 ± 30	12 x 20	31
DEX-LM3-150	384	350	260	150	180	258 ± 30	12 x 20	45
DEX-LM3-180	384	350	260	150	180	258 ± 30	12 x 20	45
DEX-LM3-220	384	350	260	150	180	258 ± 30	12 x 20	45
DEX-LM3-260	384	350	260	150	180	258 ± 30	12 x 20	45

¹⁾ The position of connection lugs U2-V2-W2 depends on the coil material and can deviate from the position illustrated here.

²⁾ Tolerance depending on air gap